



SMSEAGLE

NXS-9700-3G

NXS-9700-4G

Rev. 1, Rev. 2, Rev. 3

User's Manual



Congratulations on purchasing SMSEAGLE

The materials used in this publication are copyright and are not to be duplicated, copied, or used without the prior consent of the copyright holder. Technical specifications and information in this document are subject to change without prior notice being given.

Document version: 4.1

CONTENTS

SMSEagle Software Licensing Information	9
What's In The Box	15
Prepare for First Start.....	16
Get to know with Connectors, Ports and LEDs.....	21
Basic Operations	22
SMSEagle basic features.....	23
Compose SMS.....	23
Folders.....	24
MMS.....	25
Phonebook.....	25
Phonebook Contacts	25
Phonebook Groups	26
Phonebook Working Shifts.....	27
Users	27
Multi-User Capabilities	28
Reporting module.....	28
Statistics view	29
Settings	29
Application settings.....	30
IP Settings.....	30
Failover.....	31
Date/Time	31
Maintenance.....	32
Call Forward.....	33
MMS.....	33
Data connection.....	34
Backup/Restore.....	35
SNMP.....	36
Updates.....	36

Failover (HA-cluster) feature.....	37
SMSEagle plugins.....	41
Network Monitoring plugin.....	41
Email to SMS plugin	45
Email to SMS Poller.....	48
SMS to Email plugin	51
SMS Forward	54
Callback URL plugin	55
Periodic SMS	57
Autoreply plugin.....	58
Digital input/output	59
Temperature & humidity sensor	65
LDAP plugin	68
Blacklist	69
SMSEagle API	71
0. API Authentication.....	71
1. Send SMS: HTTP GET method.....	71
2. Send SMS/MMS: JSONRPC method	74
3. Send SMS to a group: HTTP GET method	76
4. Send SMS/MMS to a group: JSONRPC method.....	78
5. Send SMS to contact: HTTP GET method	80
6. Send SMS/MMS to contact: JSONRPC method.....	82
7. Send USSD code: HTTP GET method.....	84
8. Send USSD code: JSONRPC method	86
9. Send binary SMS: HTTP GET method.....	87
10. Send binary SMS: JSONRPC method.....	88
11. Read SMS: HTTP GET method	89
12. Read SMS/MMS: JSONRPC method	97
13. Delete SMS: HTTP GET method	111
14. Delete SMS: JSONRPC method.....	112

15. Get outgoing queue length: HTTP GET method.....	113
16. Get outgoing queue length: JSONRPC method.....	114
17. Get inbox length: HTTP GET method.....	115
18. Get inbox length: JSONRPC method.....	116
19. Get sentitems length: HTTP GET method.....	117
20. Get sentitems length: JSONRPC method.....	119
21. Get 3G/4G signal strength: HTTP GET method.....	119
22. Get 3G/4G signal strength: JSONRPC method.....	121
23. Phonebook group create: HTTP GET method.....	122
24. Phonebook group create: JSONRPC method.....	123
25. Phonebook group read: HTTP GET method.....	124
26. Phonebook group read: JSONRPC method.....	126
27. Phonebook group update: HTTP GET method.....	127
28. Phonebook group update: JSONRPC method.....	129
29. Phonebook group delete: HTTP GET method.....	130
30. Phonebook group delete: JSONRPC method.....	131
31. Phonebook group add contact: HTTP GET method.....	132
32. Phonebook group add contact: JSONRPC method.....	134
33. Phonebook group remove contact: HTTP GET method.....	135
34. Phonebook group remove contact: JSONRPC method.....	137
35. Phonebook contact create: HTTP GET method.....	138
36. Phonebook contact create: JSONRPC method.....	139
37. Phonebook contact read: HTTP GET method.....	140
38. Phonebook contact read: JSONRPC method.....	142
39. Phonebook contact update: HTTP GET method.....	144
40. Phonebook contact update: JSONRPC method.....	145
41. Phonebook contact delete: HTTP GET method.....	147
42. Phonebook contact delete: JSONRPC method.....	148
43. Call with termination: HTTP GET method.....	149
44. Call with termination: JSONRPC method.....	151

45. Phonebook shift create: HTTP GET method	152
46. Phonebook shift create: JSONRPC method.....	153
47. Phonebook shift read: HTTP GET method.....	154
48. Phonebook shift read: JSONRPC method	156
49. Phonebook shift update: HTTP GET method.....	158
50. Phonebook shift update: JSONRPC method	160
51. Phonebook shift delete: HTTP GET method	161
52. Phonebook shift delete: JSONRPC method.....	162
53. Phonebook shift add contact: HTTP GET method	163
54. Phonebook shift add contact: JSONRPC method	165
55. Phonebook shift remove contact: HTTP GET method	166
56. Phonebook shift remove contact: JSONRPC method	167
57. Get modem state: HTTP GET method.....	168
58. Get modem state: JSONRPC method.....	170
59. Set modem state: HTTP GET method.....	171
60. Set modem state: JSONRPC method	172
61. User ID read: HTTP GET method	173
62. User ID read: JSONRPC method.....	174
63. Group members read: HTTP GET method	175
64. Group members read: JSONRPC method.....	176
65. Call forward read: HTTP GET method	178
66. Call forward read: JSONRPC method	179
67. Call forward set: HTTP GET method.....	179
68. Call forward set: JSONRPC method	180
Plugins and integration manuals for NMS & Auth systems	182
Extras.....	183
Delivery Reports	183
Connecting directly to SMSEagle SQL database.....	183
Injecting short SMS using SQL	184
Injecting long SMS using SQL	185

Database cleaning scripts	187
SNMP agent	188
Setting up SNMP v3 access control.....	191
Forwarding logs to external server.....	193
Automatic software updates check.....	194
Knowledgebase & Support Portal.....	195
Troubleshooting.....	197
Verification of LEDs.....	197
Checking the device information.....	197
Device logs.....	197
When the device is not reachable	198
Restoring factory defaults	198
Service & Repair.....	201
Warranty	201
Service	201
Tech Specs & Safety Information	203
Technical Specification.....	203
Important Safety Information	206
Regulatory Statements	207
EU declaration of conformity	207
FCC compliance statement.....	207
Canadian regulatory statement	208
Avis de conformité à la réglementation d'Industrie Canada	208
RF Exposure limits	208
Disposal and recycling information	208
Restriction of Hazardous Substances Directive (RoHS)	209



**GET READY
TO START**

IMPORTANT – READ BEFORE OPERATING

SMSEAGLE SOFTWARE END USER LICENSE AGREEMENT

The herein contained End User License Agreement (the "**Agreement**" or "**License**" or "**EULA**") shall be considered a legally binding agreement between you (an individual or an entity, hereinafter "**Licensee**" or "**You**" or "**Your**") and PROXIMUS Radoslaw Janowski, ul. Piątkowska 163, Poznań, Poland, zip code 60-650 (hereinafter "**PROXIMUS**") for the use of the software preinstalled on an SMSEagle device (i.e. software which is installed and delivered together with this device), which may include related printed material and any other components and/or software modules, including but not limited to required drivers (the "**SMSEagle Software**"). Other aspects of the SMSEagle Software may also include, but not limited to software updates and any upgrades that PROXIMUS may supply to You or make available to You, or that You obtain after acquiring the SMSEagle device, and as such that said items are not accompanied by a separate license agreement or terms of use.

BY YOUR USING THE SMSEAGLE DEVICE, OR UPDATING OR UPGRADING THE SMSEAGLE SOFTWARE, YOU AGREE TO BE LEGALLY BOUND BY THE HEREIN-CONTAINED TERMS OF THIS LICENSE AGREEMENT. IF YOU DO NOT AGREE TO BE BOUND BY THE TERMS OF THIS EULA, DO NOT USE THE SMSEAGLE DEVICE AND YOU MAY CHOOSE TO PROMPTLY RETURN THE DEVICE FOR A REFUND OF ITS PURCHASE PRICE BY CONTACTING PROXIMUS AT THE ADDRESS ABOVE.

THE SMSEAGLE SOFTWARE IS PROTECTED BY COPYRIGHT LAWS, AS WELL AS ANY OTHER RELEVANT INTELLECTUAL PROPERTY LAWS. THE SMSEAGLE SOFTWARE IS LICENSED AND NOT SOLD. ALL RIGHTS INCLUDING COPYRIGHTS TO SMSEAGLE SOFTWARE REMAIN THE SOLE OWNERSHIP OF PROMIXUS, ADDITIONALLY AS STATED BELOW, THE SMSEAGLE SOFTWARE INCLUDES SOME MODULES DEVELOPED BY OTHERS, WHICH ARE SUBLICENSSED TO YOU HEREBY ACCORDING TO TERMS PERMITTED BY THE DEVELOPER.

This EULA gives you specific legal rights, and you may also have other legal rights in addition, which vary from jurisdiction to jurisdiction. The disclaimers, exclusions, and limitations of liability under this EULA will not apply only to the extent prohibited by applicable law. Some jurisdictions do not allow the exclusion of implied warranties or the exclusion or limitation of incidental or consequential damages or other rights, so in that case those provisions of this EULA may not apply to you. However, it does not prejudice the executability and applicability of all other provisions of EULA.

1. DEFINITIONS AND INTERPRETATIONS

1.01 "Agreement" or "License" or "EULA" shall mean this End User License Agreement.

1.02 "Licensee" or "You" or "Your" refers to you, the individual or business entity acquiring an SMSEagle

device on which the SMSEagle Software has been installed.

- 1.03** "Intellectual Property" means current and future worldwide rights under copyright law, patent law, trade secret law, trademark law, moral rights law, and other similar rights.
- 1.04** "Update" means maintenance of, or a fix to, a version of SMSEagle Software, including, but not limited to a hot fix, patch, or enhancement, none of which function as a standalone service or other software package and which do not have an additional cost for an existing Licensee.
- 1.05** "Upgrade" means a major, standalone version of SMSEagle Software, which may include additional applications, features, or functionality.
- 1.06** A reference to "person" includes a natural person, corporate or unincorporated body (whether or not having separate legal personality) and that person's legal and personal representatives, successors and permitted assigns.
- 1.07** Words in the singular shall include the plural and vice versa.
- 1.08** A reference to a statute, statutory provision or subordinate legislation is a reference to it as it is in force from time to time, taking account of any amendment or reenactment and includes any statute, statutory provision or subordinate legislation which it amends or re-enacts; provided that, as between the Parties, no such amendment or re-enactment shall apply for the purposes of this Agreement to the extent that it would impose any new or extended obligation, liability or restriction on, or otherwise adversely affect the rights of, any Party.
- 1.10** A reference to writing or written includes e-mail.
- 1.11** Any obligation in this Agreement on a person not to do something includes an obligation to not agree or allow that thing to be done.
- 1.12** Any phrase introduced by the terms "including", "include", "in particular" or any similar expression shall be construed as illustrative and shall not limit the sense of the words preceding those terms.
- 1.13** References to articles, sections, or clauses are to the articles, sections, and clauses of this Agreement.
- 1.14** "We", "Us", and "Our" refer to PROXIMUS Radoslaw Janowski ("PROXIMUS").
- 1.15** The "Parties" to this Agreement are You and PROXIMUS Radoslaw Janowski ("PROXIMUS").
- 1.16** "Collect" refers to transmitting data off the device in a way that allows PROXIMUS or any third-party partners to access it.

2. LICENSE GRANT

- 2.01** PROXIMUS grants to You a non-exclusive license for the use of the SMSEagle Software on the SMSEagle device on which it was preinstalled and installation of Updates and Upgrades subject

to the terms and conditions set forth herein:

(a) **Use.** PROXIMUS grants You the right to use a single instance of the SMSEagle Software on the SMSEagle device you have acquired. Use on any other device or computer is prohibited.

(b) **Backup Copy.** You may retain a single copy of the current version of SMSEagle Software for Your SMSEagle device as may be necessary for backup purposes.

2.02 Furthermore, this EULA shall also cover any and all software Updates and Upgrades provided by PROXIMUS that would replace, overwrite and/or supplement the original installed version of the SMSEagle Software, unless those other Updates and Upgrades are covered by a separate license, in which case the terms of that license will govern.

3. INTELLECTUAL PROPERTY

3.01 PROTECTED SMSEAGLE SOFTWARE. The SMSEagle Software is protected by copyright and other Intellectual Property laws and treaties.

3.02 RESTRICTIONS ON USE. As a Licensee, You may not: (a) Make use of the SMSEagle Software on more than one device at a time, without prior purchase of additional devices; (b) Share or otherwise make available the SMSEagle Software, in any manner whatsoever, to any third party (c) Modify, adapt, create derivative works from or translate any part of the SMSEagle Software other than what may be used within Your SMSEagle device in accordance with this License; (d) Reverse engineer, decompile or disassemble the SMSEagle Software, nor attempt to locate or obtain its source code; (e) Attempt to alter or remove any trademark, copyright or other proprietary notice contained within the SMSEagle Software; or (f) Make use of SMSEagle Software in any manner not stipulated within this EULA or the documentation accompanying the SMSEagle device on which it was preinstalled.

3.03 UPDATES/UPGRADES. PROXIMUS may find it appropriate to make available Updates or Upgrades to the SMSEagle Software. You may initiate the process for installing any Update or Upgrade such as by clicking a button "Check for software updates now" in the SMSEagle device's web interface. Alternatively (when the device has no Internet access) You may obtain an Update or Upgrade package from SMSEagle support at <https://support.smseagle.eu> to be later installed on the SMSEagle device. It shall be at the sole discretion of PROXIMUS to make conditional releases of said Updates or Upgrades to You upon Your acceptance of another EULA or execution of another separate agreement. Deciding to install and make use of these Updates or Upgrades, You agree to be subject to all applicable license, terms and conditions of this EULA and/or any other agreement.

4. DISCLAIMER OF WARRANTY

PROXIMUS shall use reasonable efforts consistent with prevailing software development

standards to maintain SMSEagle Software in a manner which minimizes errors and interruptions.

HOWEVER, PROXIMUS NEITHER WARRANT THAT THE USE OF SMSEAGLE SOFTWARE WILL BE UNINTERRUPTED OR ERROR-FREE; NOR MAKE ANY WARRANTY AS TO THE RESULTS THAT MAY BE OBTAINED FROM USE OF SMSEAGLE SOFTWARE.

TO THE FULLEST EXTENT PERMITTED BY APPLICABLE LAW, EXCEPT AS EXPRESSLY PROVIDED HEREIN AND NOTWITHSTANDING ANYTHING TO THE CONTRARY, NEITHER PROXIMUS NOR ANY OFFICER, DIRECTOR, SUBSIDIARY, AFFILIATE, AUTHORIZED RESELLER, OR EMPLOYEE THEREOF, MAKES ANY OTHER WARRANTY OF ANY KIND, WHETHER EXPRESS, IMPLIED, STATUTORY OR OTHERWISE, INCLUDING, BUT NOT LIMITED TO, WARRANTIES OF MERCHANTABILITY, FITNESS FOR A PARTICULAR USE, AND NONINFRINGEMENT.

5. LIMITATION OF LIABILITY AND REMEDIES

IN SPITE OF ANY DAMAGES ARISING FROM OR RELATED TO THE SMSEAGLE DEVICE AND SMSEAGLE SOFTWARE OR ITS OPERATION THAT YOU MAY INCUR FOR ANY REASON, WHICH MAY INCLUDE, BUT ARE NOT LIMITED TO, ANY AND ALL DAMAGES IN CONTRACT, TORT OR OTHERWISE, THE ENTIRE LIABILITY OF PROXIMUS AND/OR ANY OF THE AFOREMENTIONED PERSONS REFERRED TO IN SECTION 4 ABOVE, AS WELL AS ANY LICENSORS REFERRED TO IN SECTION 6 BELOW, SHALL NOT EXCEED YOUR TOTAL PAYMENTS (IF ANY) WITH RESPECT TO THE PERTINENT SMSEAGLE DEVICE, WHICH HAS BECOME DUE FOR DURING THE PERIOD OF PRIOR 12 MONTHS BEFORE THE MONTH DAMAGE HAS BEEN SUFFERED. THIS LIMITATION IS CUMULATIVE AND SHALL COVER THE TOTAL FOR ALL SUCH INCIDENTS AND CLAIMS. THE AFOREMENTIONED LIMITATIONS, EXCLUSIONS AND ANY DISCLAIMERS SHALL APPLY TO THE MAXIMUM EXTENT ALLOWABLE BY LAW, EVEN SHOULD ANY PROPOSED REMEDY FAIL OF ITS ESSENTIAL PURPOSE.

6. OPEN SOURCE

Certain software modules in the PROXIMUS Software are subject to "open source" or "free software" licenses ("Open Source Software"). Some of the Open Source Software is owned by third parties. Such Open Source Software is not subject to the terms and conditions of this Agreement. Instead, each item of Open Source Software is licensed under the terms of the end user license that accompanies such Open Source Software. Nothing in this Agreement limits your rights under, or grants you rights that supersede, the terms and conditions of any applicable end user license for the Open Source Software. Applicable Open Source licenses include the: MIT License; GNU General Public License v. 2.0; GNU Lesser General Public License v. 2.1; BSD-3 Clause License; Apache License 2.0. If required by any license for particular Open Source Software, PROXIMUS makes such Open Source Software, and Our modifications to that Open Source Software, available by written request to Us at the email or mailing address.

7. U.S. GOVERNMENT END USERS

The SMSEagle Software is licensed to the U.S. Government with RESTRICTED RIGHTS. The use, duplication of, or the disclosure thereof by the U.S. Government, shall be subject to restrictions in accordance with DFARS 252.227-7013 of the Technical Data and Computer Software clause, and 48 DCR 52.227-19 of the Commercial Computer Software clause, as applicable.

8. DATA PRIVACY

8.01 DATA COLLECTION STATEMENT. PROXIMUS does NOT collect ANY data you are working with when You use SMSEagle device. We could not see or collect any data saved on SMSEagle device, because we do not have any access to Your device.

8.02 GDPR. For your rights according to European Union General Data Protection Regulation (GDPR) see Privacy Policy available under this website: <https://www.smseagle.eu/privacy-policy/>

9. MISCELLANEOUS

9.01 SUCCESSORS AND ASSIGNS. This EULA, in its entirety, shall be legally binding upon and inure to the benefit of PROXIMUS and You, our respective successors and permitted assigns.

9.02 SEVERABILITY. If any provision of this Agreement is held to be illegal, invalid or unenforceable by a tribunal of competent jurisdiction, the remaining provisions shall not be affected.

9.03 WAIVER. If there is any waiver of any breach or failure to enforce any of the provisions contained herein, it shall not be deemed as a future waiver of said terms or a waiver of any other provision of this EULA.

9.04 AMENDMENTS. Any waiver, supplementation, modification or amendment to any provision of this EULA, shall be effective only when done so in writing and signed off by PROXIMUS.

9.05 GOVERNING LAW. In matters not regulated herein the provisions of the Polish Civil Code shall apply and provisions of Polish Copyright Act, 4th February 1994 (Journal of Laws 1994, No. 24, item 83). This Agreement shall be governed in all respects by the laws of the Republic of Poland.

9.06 DISPUTE RESOLUTION. All disputes arising from the present Agreement and/or in connection with it shall be finally decided with the Arbitration Court attached to the Czech Chamber of Commerce and the Agricultural Chamber of the Czech Republic according to its Rules by one arbitrator appointed by the President of the Arbitration Court.

9.07 ASSIGNMENTS. You may not transfer the SMSEagle device on which SMSEagle Software is installed unless the transferee agrees to the terms of this Agreement.

9.08 VALID AND BINDING. This Agreement constitutes a valid and legally binding obligation of the Parties, enforceable against the Parties in accordance with its terms, subject in all respects to the effects of bankruptcy, insolvency, fraudulent conveyance, reorganization, moratorium and other laws relating to or affecting creditors' rights generally and general equitable principles.

9.09 EFFECT OF TITLE AND HEADINGS. The title of the Agreement and the headings of Sections, and Clauses are included for convenience and shall not affect the meaning of the Agreement or the Section.

9.10 FORCE MAJEURE. Except for payment obligations, if either Party is prevented from performing or is unable to perform any of its obligations under this Agreement due to causes beyond the reasonable control of the Party invoking this provision, including but not limited to acts of God,

acts of civil or military authorities, riots or civil disobedience, wars, strikes or labor disputes (each, a "**Force Majeure Event**"), such Party's performance shall be excused and the time for performance shall be extended accordingly provided that the Party promptly takes all reasonably necessary steps to resume full performance.

- 9.11** The provisions of this EULA do not prejudice the provisions on consumer protections and entrepreneur protection if You are a natural person who buys the device and conclude this EULA not connected directly with its business or professional activity or in case of entrepreneur being a natural person – not connected directly with its professional activity (applied to the EULA concluded from January 1st, 2021). If any provision of this EULA is inconsistent with mandatory consumer or individual entrepreneur's protection laws, the provision does not bind the consumer/individual entrepreneur and the provision of commonly binding law closest to that provision shall apply.

10. CONTACT INFORMATION

If you have questions regarding this EULA, please contact PROXIMUS at:

Ul. Piątkowska 163
60-650 Poznań
Poland | Europe
tel. + 48 61 6713 413
<https://www.smseagle.eu>
hello@smseagle.eu
support@smseagle.eu

WHAT'S IN THE BOX

Your SMSEagle box contains:

- SMSEagle hardware SMS gateway
- External omnidirectional antenna (with magnetic foot)
- **AC/DC power supply (input voltage: 100-240V)**
- Warranty card



PREPARE FOR FIRST START

Your SMSEagle is designed so that you can set it up quickly and start using it right away. Follow the steps below to get started.

STEP 1: Install 3G/4G antenna

ANTENNA INSTALLATION GUIDELINES

- Install the antenna in a location with access to a cellular network radio signal.
- The antenna must be installed such that it provides a separation distance of at least 20 cm from all persons and must not be co-located or operating in conjunction with any other antenna or transmitter.
- The antenna must not be installed inside metal cases.

Plug in antenna connector to the device.

STEP 2: Insert SIM Card

Please install SIM Card when the device is SWITCHED OFF. SIM Card slot is located at the bottom of the device. Use a ball-pen or small screwdriver to eject SIM Card tray. Insert card into tray and push it gently into slot.



STEP 3: Power the device

The device is powered with AC/DC power supply adaptor delivered in the box. The device needs a power source of 12V DC / 1A. In order to power the device simply plug in a connector from AC/DC adaptor into the device.

PREPARE FOR FIRST START

STEP 4: Configure IP settings



SMSEAGLE DEFAULT NETWORK CONFIGURATION:

DHCP CLIENT IS ON

(IP ADDRESS WILL BE OBTAINED AUTOMATICALLY FROM YOUR DHCP SERVER)

A) CONNECT SMSEAGLE TO YOUR LAN AND **OBTAIN IP ADDRESS AUTOMATICALLY**

- connect the device to your LAN using Ethernet cable
- SMSEagle will obtain IP address automatically from your DHCP
- read assigned IP address on your DHCP server

B) **OR** SET IP ADDRESS FOR SMSEAGLE MANUALLY

- connect a display using HDMI connector, connect a keyboard to USB port (note: cables are not provided)
- login to the SSH console using root credentials (these were provided with your device)
- edit configuration file with command:
mcedit /mnt/nand-user/smseagle/syscfg
change the following lines:
HOST_IP= (*set IP address for your device*)
GW_IP= (*default gateway IP address*)
NET_MASK= (*set subnet mask*)
START_DHCP=Y (*set to START_DHCP=N to disable DHCP client*)
- save and exit the file
- shutdown the device
- now connect SMSEagle to your LAN using Ethernet cable

PREPARE FOR FIRST START

C) LOG IN TO SMSEAGLE

Open an internet browser on your PC and go to the IP address assigned to your gateway

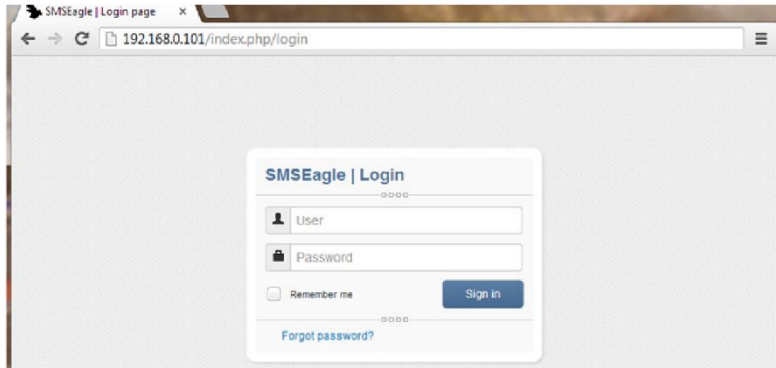

SMSEAGLE DEFAULT USER:

Username: admin

Password: password

Login to application with above username and password.

D) CONFIGURE STATIC IP SETTINGS IN WEB-GUI (OPTIONAL)

Click on menu position “Settings” and navigate to tab “IP Settings”.

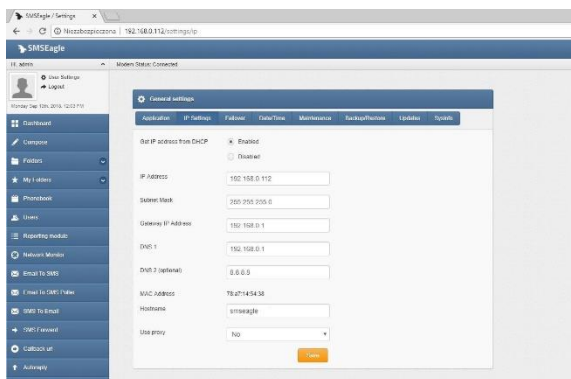

Disable DHCP server. Enter your IP settings. > Press “Save” button.

Save

PREPARE FOR FIRST START

STEP 5: Setting SIM Card PIN

This step should ONLY be done if your SIM-card requires PIN.

If your SIM-card requires PIN number at startup, go to Settings > **Maintenance Tab**.

Enter your PIN number in the field "SIM Card PIN"

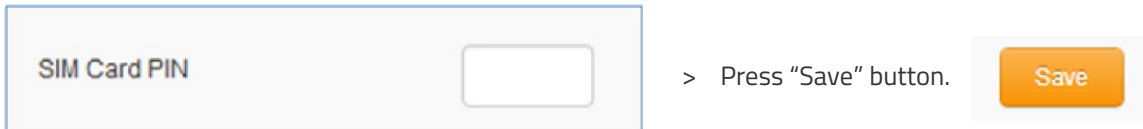

The screenshot shows a settings interface with a text input field labeled "SIM Card PIN" and a "Save" button. To the right of the input field, there is a text instruction: "> Press 'Save' button."

STEP 6: Installing custom SSL certificate and HTTPS-only (OPTIONAL)

Using HTTPS only

By default, SMSEagle webGUI can be accessed via HTTP or HTTPS. For improved security we recommend using HTTPS. If you would like to redirect HTTP > HTTPS, follow this [knowledgebase article](#).

Installing your own SSL certificate

SMSEagle device comes with a self-signed SSL certificate. You may install your own SSL certificate or a free Let's Encrypt SSL certificate by following these [knowledgebase articles](#).

STEP 7: Reboot the device

Go to Settings > Maintenance Tab. Press **Reboot** button.

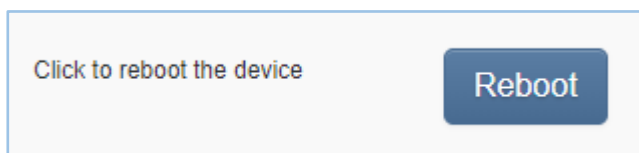

The screenshot shows a button labeled "Reboot" and a text instruction "Click to reboot the device".



USING OF SMSEAGLE

GET TO KNOW WITH CONNECTORS, PORTS AND LEDs

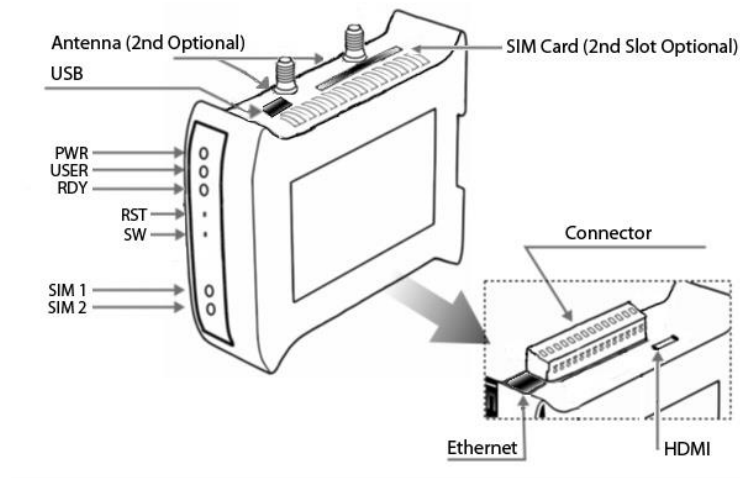

Element	Label	Description
VCC (Rev.3 only)	VCC	Power connector
12-pole connector	-	Hardware Rev.3: 4x digital Input, 4x digital output, 1x 1Wire, 1x 5V, 2x GND Hardware Rev. 2, Rev.1: Power connector, 2x digital input, 2x digital output, 2x serial port, 2x GND
SIM Card Slot	SIM1, SIM2 (optional)	SIM card slot(s)
HDMI port	HDMI	HDMI port (for debugging purposes only)
USB port	USB	USB port
Ethernet Port	ETH	Ethernet RJ45 port
Antenna	ANT	Antenna socket
Power LED	PWR	LED indicating power-on
User LED	USER	LED for user application purpose
SIM1,2 LEDs	Modem 1,2 (optional)	LED indicator for modem status (only in 3G devices)
Ready LED	RDY	LED indication device status
Reset	RST	Switch for rebooting the device
User Switch	SW	Switch for restoring to factory settings

BASIC OPERATIONS

SMSEagle is capable of working at various screen resolutions, making it accessible for wide range of devices: computers, laptops, tablets, smartphones, etc.



Open a web browser on your device, type in SMSEagle's IP address (as set in previous chapter). At login screen type in your username/password. Default username and password is given in chapter **Prepare for First Start**.

SMSEAGLE BASIC FEATURES

- Sending & Receiving SMS (managing messages with Inbox, Outbox, Sent Items). Different message types (normal SMS, flash, WAP push, USSD codes)
- Sending & Receiving MMS (webGUI & API)
- Smartphone-like conversation mode (messages are nicely grouped by phone number). You can easily track history of what you send and receive
- Sending to single numbers, contacts or groups from phonebook
- Import messages for sending from CSV file
- SMS Scheduling by specified date and time or delay
- SMS sending within specified time window (between selected hours)
- Message templates (save & edit your own templates)
- Unicode support (support of national characters)
- Multiuser support (each user has access to a private Inbox, Outbox, Sent Items)

Compose SMS

Here we show the various ways of sending an SMS form your device.

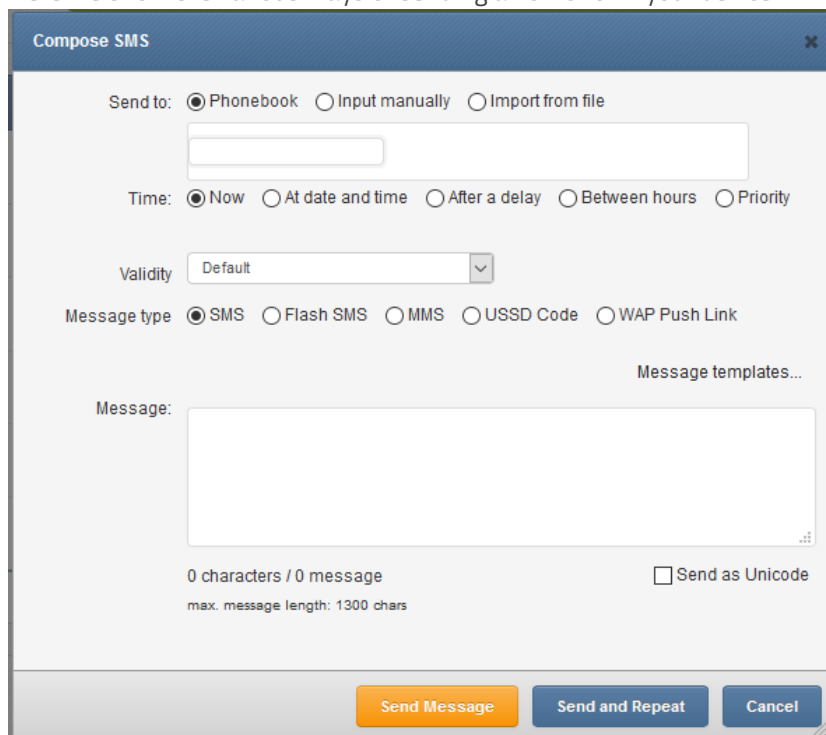

Screenshot of default Compose SMS view

In Compose SMS users can:

- Send SMS to contact from phonebook, input manually or import from file
- When importing from file each column can be used as a placeholder in the message. During sending the placeholder will be replaced by a unique value for each imported row from CSV file.
- Set send date to now, at a date and time, after a delay, between selected hours or with high priority
- Set duration validity of SMS

- Type of SMS, normal, flash, MMS, WAP Push Link or USSD Code
- Set a message template to be saved and used at another time
- Send as Unicode (for special character use)
- Send message or Send and Repeat (window remains open, allowing modifications to next message)

Folders

Folders contain your messages. They are conveniently grouped into 5 categories:

- Inbox
- Outbox
- Sent Items
- Spam
- Trash

The view of conversations can be either of type “Baloons” (smartphone like conversation) or “Table” (tabular view). The view type can be changed in menu Settings > Application.

Baloons view type:

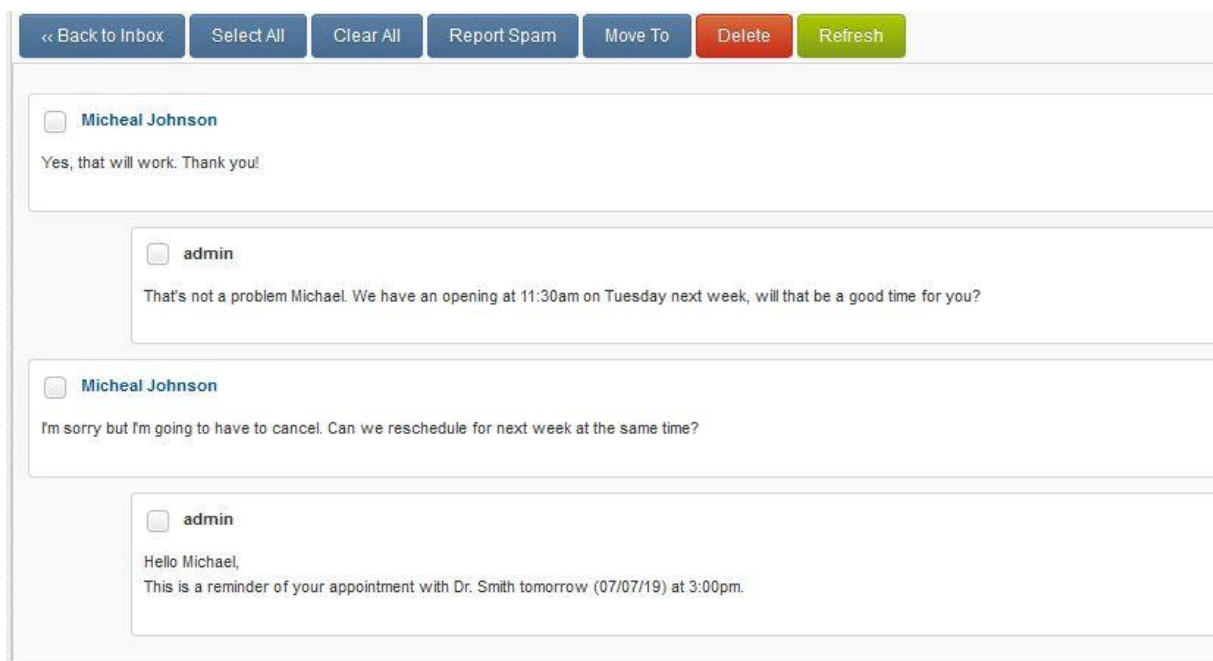

Table view type:

<input type="checkbox"/>	Date	From/To	Created by	Message
<input type="checkbox"/>	3 minute ago	Micheal Johnson ↓		- Yes, that will work. Thank you!
<input type="checkbox"/>	4 minute ago	Micheal Johnson ↑	admin	- That's not a problem Michael. We have an opening at 11:30am on Tuesday next week, will that be a ...
<input type="checkbox"/>	7 minute ago	Micheal Johnson ↓		- I'm sorry but I'm going to have to cancel. Can we reschedule for next week at the same time?
<input type="checkbox"/>	9 minute ago	Micheal Johnson ↑	admin	- Hello Michael, This is a reminder of your appointment with Dr. Smith tomorrow (07/07/19) at 3:00...

MMS

To view an MMS attachment, you need to click “show MMS attachment” in the inbox message.

Folder > inbox > +48 [redacted]

<< Back to Inbox
Select All
Clear All
Report Spam
Blacklist number
Move To
Delete
Refresh

+48 [redacted]

1 minute ago | Show Details

Hello, attached is the image you've requested.

➔ Show MMS attachments

<< Back to Inbox
Select All
Clear All
Report Spam
Blacklist number
Move To
Delete
Refresh

Phonebook

Web-GUI of SMSEagle device is equipped with Phonebook for managing contacts, groups and shifts. Each user can create private and public contacts, gather contacts in private and public groups. Contacts can also be optionally assigned to working shifts. Contacts and groups from Phonebook allows users efficient sending of messages.

Phonebook Contacts

Below we present a main Phonebook view, where user manages his Contacts.

Contacts
+ Add Contact
Public Contacts
Manage Groups
Manage Shifts

Select All
Clear All
Delete
Action

Contact name	Groups	Shifts	Manage
<input type="checkbox"/> contact sample 12345	private		Edit Send Message See conversation
<input type="checkbox"/> sample contact 111111111	work		See conversation

Select All
Clear All
Delete
Action

Screenshot of default phonebook view

In Phonebook Contact Management users can:

- Add/edit/delete contacts via web-gui
- Import contacts from CSV file

- Set contact to public or private visibility
- Add contacts to groups
- Add contacts to working shifts
- Send message to a contact
- View message conversation of a contact

Screenshot of Edit/Add Contact window

In Phonebook Contact Edit/Add window users can:

- Define Contact name and Telephone number
- Choose if contact is Private/Public
- Add contact to a Group
- Add contact to a Working Shift
- Enable/disable Vacation mode (messages are not sent when Vacation mode is enabled)

Phonebook Groups

Screenshot taken from phonebook groups

In Phonebook Group Management view users can:

- Add/edit/delete groups
- Set groups to public or private visibility
- View group content (contacts belonging to the group)
- Send message to a group

Public and Private Contacts/Groups

Public contacts/groups are visible to all users on the device. A public contact/group may only be edited by the owner (the user who created the contact/group) . Private contacts/groups are visible to a single user (the owner).

Phonebook Working Shifts

The Shift management feature allows to assign Phonebook contacts to work in shifts. If a contact is assigned to any working shift, before sending a message the device will check if the contact is on a working shift. If the contact is not on shift the message will be skipped or moved to beginning of a next shift. To start using working shifts define shifts here and add contact to a shift in contact details.

The Shift management feature allows to assign Phonebook contacts to working shifts. If a contact is assigned to any working shift, before sending a message the device will check if the contact is on a working shift. If the contact is not on shift the message will be skipped or moved to beginning of a next shift. To start using working shifts define shifts here and add contact to a shift in contact details.

No.	Shift name	Monday	Tuesday	Wednesday	Thursday	Friday	Saturday	Sunday	Manage
1	A.Morning	08:00-16:00	08:00-16:00	08:00-16:00	08:00-16:00	08:00-16:00	-	-	Edit Delete Disable
2	B.Evening	16:00-23:59	16:00-23:59	16:00-23:58	16:00-23:59	16:00-23:59	-	-	Edit Delete Disable

When contact is not on shift: Save

Screenshot of shift management in phonebook

Users

The Users function allows you to manage access to your device. It allows you to add, edit and remove users and set their permissions. There are two access levels for a user:

- User role "Administrator":

Allows full access & control of the device including settings and User management.

- User role "User":

Limits access only allowing to Compose, Folders, Phonebook and Reporting module.

The screenshot shows a 'Edit/Add User' dialog box with the following fields and options:

- Name:** User 1
- Phone access number (for password reminder):** 987456123
- Username:** User1
- New password:** [masked]
- Confirm Password:** [masked]
- Level:** User
- Access to API:** On
- API Access token:** Enable token. A 'Generate new token' button is present next to the checkbox.

At the bottom of the dialog are 'Save' and 'Cancel' buttons.

Screenshot of Edit/Add User window

Multi-User Capabilities

As described in the “Users” chapter, SMSEagle software allows to create multiple users with different access levels (Administrator or User). Those users may access the device simultaneously via webGUI or API. The following set of features is available in multi-user work scenario:

- Multiple users may access the device simultaneously via webGUI or API
- Each user can create private or public (shared) Phonebook contacts and groups (*see details in “Phonebook” chapter*)
- Users with “User” role has its own private sent items folder (they cannot see messages sent by other users). Users with “Administrator” role can see messages sent by all users.
- the content of inbox folder (incoming messages) may be visible: for everybody or only for “Administrator” role (*see details in “Application settings” chapter*)

Reporting module

Reporting module is an extension of basic search feature. The module allows users to filter messages from Inbox/Sent items folders based on custom criteria and display filtered messages. Filtered list of messages can be exported to PDF or CSV file.

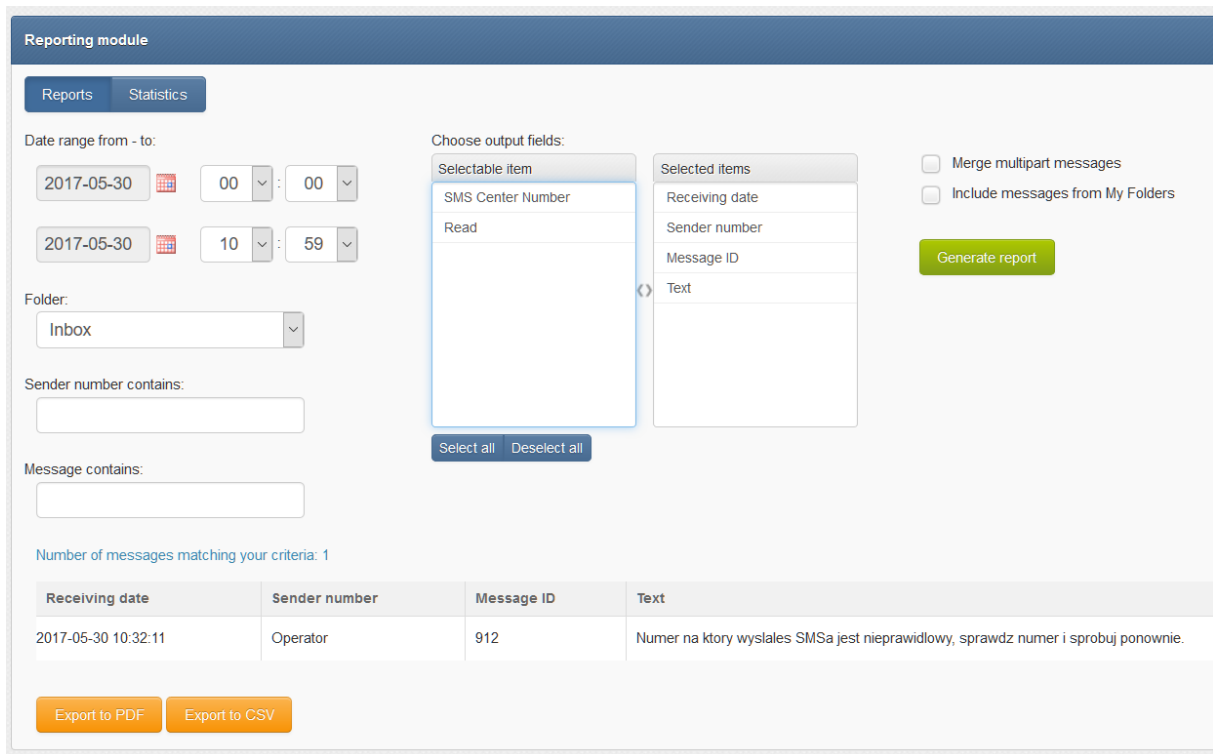

Screenshot of Reporting module

Statistics view

The reporting module allows also to view daily statistics of sent/received messages. The statistics view displays number of messages per day and sender/receiver number.

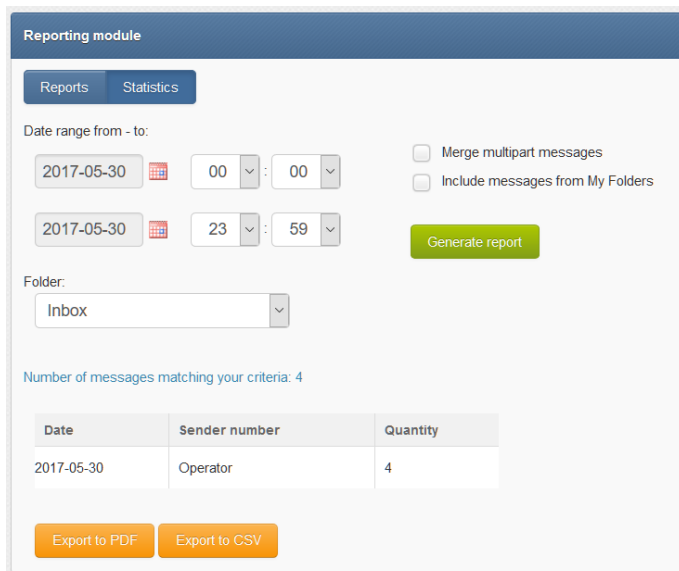

Screenshot of Statistics view in Reporting module

Settings

Settings menu is divided into several tabs for easier maintenance.

Application settings

Application settings can be changed under the Settings Tab > Application.

General settings

Application IP Settings Failover Date/Time Maintenance MMS Data conn. SNMP Backup/Restore Updates Sysinfo

Language English

Country dial code POLAND (+48)

Conversation sort Newest First

Conversation view type Balloons

Data per Page 15 Will be used for paging in message and phonebook

Permanent delete Permanent delete Off - Always move to Trash first
 Permanent delete On

Delivery Report No

Inbox content visibility For all users

Reporting module accessible for All users

Sending delay between SMS 0 in seconds (0 = no delay)

Access to DB for external applications Enable

Save

- You can change the language of the application to English, French, German, Polish and Spanish
- You can change the country dial code to your country (this setting affects only correct assignment of phone numbers to phonebook entries)
- You can sort the conversation to show messages either “Newest First” or “Oldest First”
- You can change the conversation view to either “Table” (tabular view) or “Balloons” (smartphone-like view), as shown in Folders chapter
- You can adjust the amount of data displayed on one page to 10, 15, 20, 25, 50, 100, 250 or Show all
- You can set for the messages to be permanently deleted or be moved to Trash first
- You can set the receiving of delivery reports to Yes, No or Default (network carrier setting)
- You can set the visibility of the Inbox content to All users or Only admins
- You can set access of the reporting module to All users or Only admins
- You can set a delay between SMS sending in seconds (this setting may be useful for cases where cellular operator blocks a number due to intensive traffic. Note: setting delay between SMS sending also introduces a delay time between receiving SMS)
- You can enable or disable access to database for external applications

IP Settings

IP settings can be changed under the Settings tab > IP Settings.

General settings

Application IP Settings Failover Date/Time Maintenance Call forward MMS Data conn. Backup/Restore Updates

Sysinfo

Get IP address from DHCP Enabled
 Disabled

IP Address

Subnet Mask

Gateway IP Address

DNS 1

DNS 2 (optional)

MAC Address 78:a7:1

Hostname

Use proxy

- You can enable or disable Get IP address from DHCP
- You can input the IP address
- You can input the Subnet Mast
- You can set the Gateway IP Address
- You can set DNS 1
- You can optionally set DNS 2
- You can view the MAC address of your device
- You can input Hostname
- You can choose to Use proxy

Failover

Failover configuration has been described in chapter "[Failover \(HA-cluster\) feature](#)".

Date/Time

Date/Time settings can be changed under the Settings Tab > Date/Time

General settings

Application | IP Settings | Failover | **Date/Time** | Maintenance | Call forward | MMS | Data conn. | Backup/Restore

Updates | Sysinfo

Current date and time: 2021-01-14 11:31

Set time zone: Europe/Warsaw

Automatic time synchronization with NTP timeserver: On, use external NTP server

If you choose "create NTP server", date & time will be obtained from GSM/3G network and SMSEagle will serve as NTP-server

NTP timeserver address: pl.pool.ntp.org

Save

- You can check current device date and time
- You can set your time zone
- You can set automatic time synchronization with NTP timeserver, disable automatic time synchronization or create NTP server on SMSEagle device (date & time will be obtained from 3G/4G network)
- You can set NTP timeserver address

Maintenance

Maintenance settings can be accessed under the Settings tab > Maintenance

General settings

Application | IP Settings | Failover | Date/Time | **Maintenance** | Call forward | MMS | Data conn. | Backup/Restore

Updates | Sysinfo

Click to reboot the device: Reboot

Modem enabled?:

SIM Card PIN:

SIM Card PUK:

Save

- You can reboot your device
- You can enable or disable the device modem
- You can input your SIM card PIN
- You can input your SIM card PUK

Call Forward

Important Notice: This feature is available only devices with 3G modems.

Call forward settings can be accessed under the Settings tab > Call forward.

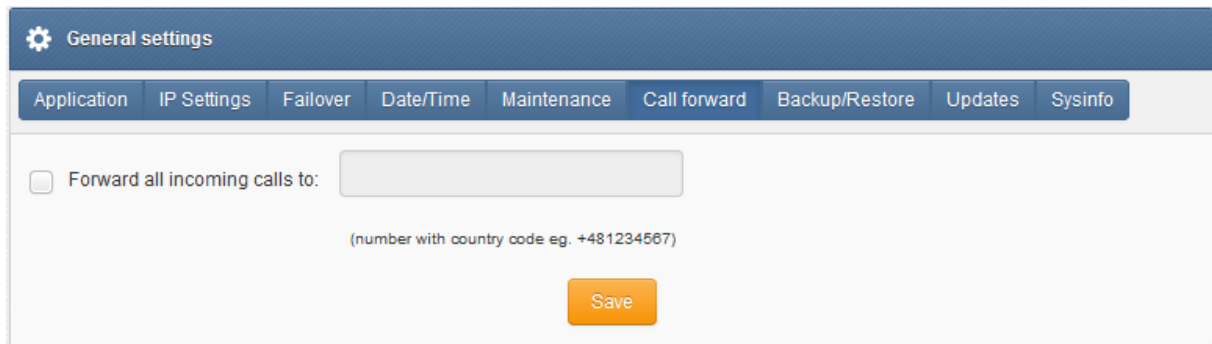

The screenshot shows the 'General settings' screen with a navigation bar at the top containing tabs for 'Application', 'IP Settings', 'Failover', 'Date/Time', 'Maintenance', 'Call forward', 'Backup/Restore', 'Updates', and 'Sysinfo'. The 'Call forward' tab is selected. Below the navigation bar, there is a checkbox labeled 'Forward all incoming calls to:' followed by a text input field. Below the input field, there is a small text label '(number with country code eg. +481234567)'. At the bottom of the screen, there is an orange 'Save' button.

- You can choose to forward all incoming calls to a chosen number

MMS

MMS Settings can be accessed under the Settings tab > MMS.

⚙️ General settings

Application IP Settings Failover Date/Time Maintenance Call forward MMS Data conn. Backup/Restore

Updates Sysinfo

Enable MMS support

APN

Username

Password

MMSC

MMS Proxy

MMS Port

Enable autoresponder for incoming MMS messages

MMS autoresponder message

Warning: MMS messages are ignored. Please send your message again as SMS.

- You can enable MMS support
- You can set APN value
- You can input APN username
- You can input APN password
- You can set MMSC
- You can set MMS Proxy
- You can set MMS Port
- You can set autoresponder for incoming MMS messages
- You can input MMS autoresponder message

****The values for all fields can be found on the website of your SIM-card operator****

Data connection

Data connection settings can be accessed under the Settings tab > Data conn.

Here you can control a mobile data connection on your device. It can be used, for example, to utilize SMSEagle as a backup Internet source. **Data connection is NOT REQUIRED for normal operation** of SMSEagle device. Leave it disabled (OFF) if you don't want to use it.

General settings

Application IP Settings Failover Date/Time Maintenance Call forward MMS Data conn. Backup/Restore

Updates Sysinfo

Here you can control a mobile data connection on your device. It can be used, for example, to utilize SMSEagle as a backup Internet source. Data connection is NOT REQUIRED for normal operation of SMSEagle device. Leave it disabled (OFF) if you don't want to use it.

Data connection autostart ON

Internet APN

Username

Password

Access number

IP Address

Save

- You can choose to autorestart data connection
- You can input Internet APN
- You can input APN username
- You can input APN password
- You can input access number
- You can view the IP address of your device

****The values for all fields can be found on the website of your SIM-card operator****

Backup/Restore

Backup and restore settings can be accessed under the Settings tab > Backup/Restore

The screenshot shows the 'General settings' interface with the 'Backup/Restore' tab selected. Under 'Backup device settings', there is a blue 'Create backup' button. Under 'Restore device settings', there is a 'No file selected' button, a 'Choose File' button, a checkbox for 'Restore database' (which is unchecked), and an orange 'Restore from backup' button.

- You can create a backup of your device settings
- You can restore device settings from a previously saved file
- You can choose to additionally restore the database

WARNING Restore backup settings only works with the same version of device and software

SNMP

SNMP Settings can be accessed under the Settings tab > SNMP

The screenshot shows the 'General settings' interface with the 'SNMP' tab selected. The 'SNMP daemon autostart' dropdown menu is set to 'Yes'. The 'SNMP Community' text input field contains the value 'public'. An orange 'Save' button is located at the bottom center of the form.

- You can enable/disable SNMP daemon
- You can set your SNMP community name (custom value)

SNMP daemon is required only when you want to monitor your device from external monitoring solutions like Network Monitoring Systems, etc. You can read more about custom SNMP metrics available on SMSEagle device in SNMP agent chapter.

Updates

Update settings can be accessed under the Settings tab > Updates.

SMSEagle software is under process of continual improvement. We listen to our customers, and new releases are based on our customer's inputs/requests. Software updates are released frequently, and offer access to new features and fixes to reported issues. Web-GUI offers you a possibility to automatically check for new software updates. This can be done in two ways:

MANUAL CHECK

In order to manually check for available software updates, go to menu Settings > tab Maintenance. Click on the button "Check manually now". At the top pops up a balloon in red with information if it is up-to-date.

AUTOMATIC CHECK

In order to start automatic checks for software updates go to menu Settings > tab Maintenance, and check the option "Automatically check for software updates". This will enable periodic checks (once a month) for available software updates. If a new update is available, a message "Update Available" will appear in menu Settings> Sysinfo – next to the current software version number.

If you select "Notify Admin about new software version by SMS", the device will additionally send SMS to the default admin account (if the phone number is entered in the account) with a notification about new software update.

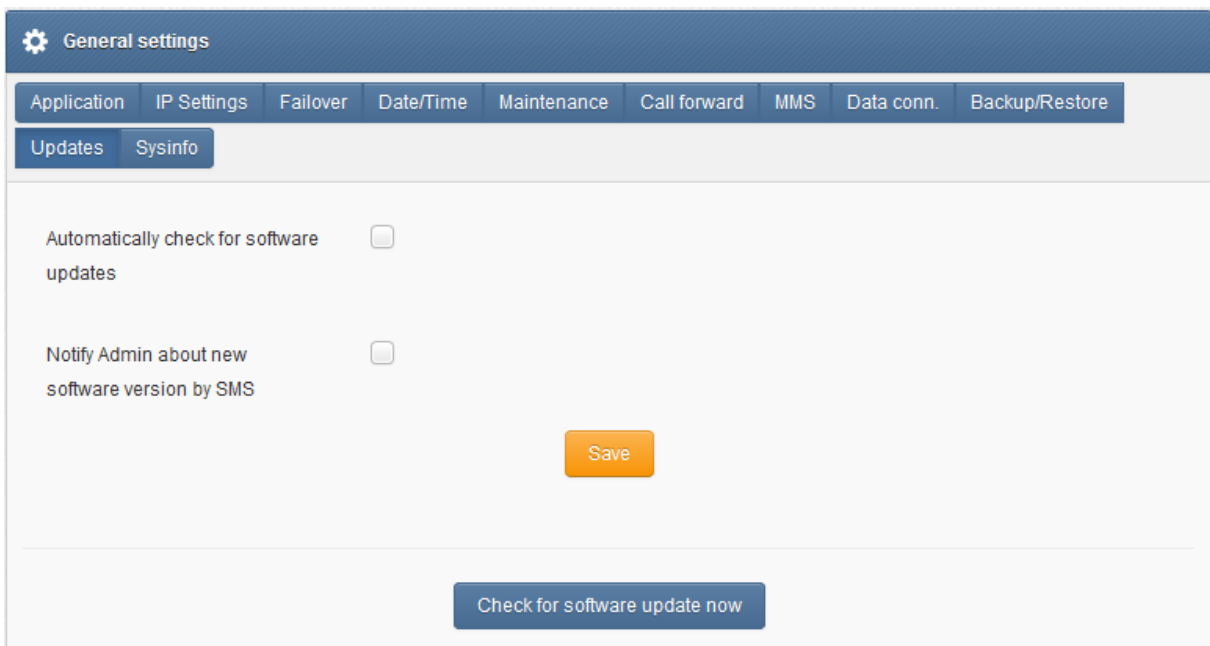

Screenshot from "General Settings-Maintenance"

Notice: Your SMSEagle device must have a HTTPS connectivity with address updates.smseagle.eu in order for this feature to work.

Failover (HA-cluster) feature

'High-availability clusters (also known as HA clusters or fail over clusters) are groups of computers (...) that can be reliably utilized with a minimum of down-time. They operate by using high availability software to harness redundant computers in groups or clusters that provide continued service when system components fail. Without clustering, if a server running a particular application crashes, the application will be unavailable until the crashed server is fixed. HA clustering remedies this situation by detecting hardware/software faults, and immediately restarting the application on another system or whole node without requiring administrative intervention, a process known as failover.' (source: Wikipedia)

SMSEagle NXS-family devices have their own failover mechanism based on HA-cluster. This feature allows you to assure high availability of SMSEagle devices in critical environments. To enable failover (HA-cluster) you need 2 devices ('aka' nodes). The failover feature monitors devices working in the cluster, and detects faults with the following services:

1. Apache2 WWW server
2. PostgreSQL database
3. SNMP agent
4. Modem software (Gammu-SMSD daemon)
5. Accessibility (response to ping) of whole node.

Every node in a cluster can have one of three states:

- **Master:** main healthy node in a cluster, by default accessible through Virtual IP
- **Backup:** second healthy node in a cluster, ready and waiting for replacing Master when needed
- **Fault:** node with detected service fault

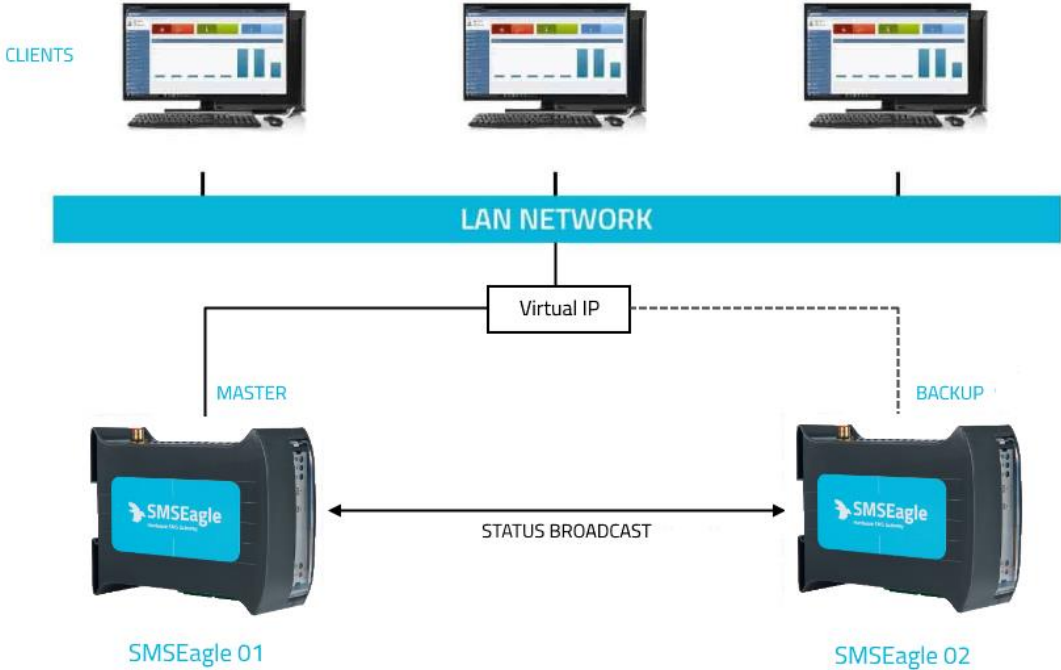

In the cluster you have one MASTER device and one BACKUP device. **HA-cluster is accessed via Virtual IP address.** When the daemon running at MASTER device detects failure of at least one described feature it immediately automatically switches cluster's IP assignment to the BACKUP device (node) providing continuous usage of the SMSEagle HA-cluster for the user.

Devices (nodes) should see each other on the network. By default, HA-nodes use 224.0.0.18 multicast IP address for VRRP (Virtual Router Redundancy Protocol) for communication between two nodes. If nodes are on the same network (same subnet & IP range) there is no need for any network configuration. If two nodes are behind firewalls, make sure firewall is configured to accept multicast and VRRP protocol (IP Protocol #112).

HOW TO CONFIGURE FAILOVER (HA-CLUSTER):

Failover cluster can be easily configured using web-gui. Configuration can be done in menu "Settings" > tab "Failover". The configuration should be exactly the same on both devices in HA-cluster.

Please configure first MASTER then BACKUP device. For **each** device in failover cluster:

- enter virtual IP address in the field "Virtual IP Address"
- enter Master and Backup IP addresses (these should be physical addresses of your devices)
- set "Enable Failover cluster" to "Yes"
- optionally you can enable database replication between nodes (feature available only in devices with hardware Rev.2 and higher)

Save configuration. **Reboot** each device after saving.

General settings

Application IP Settings Failover Date/Time Maintenance Backup/Restore Updates Sysinfo

Enable Failover cluster Yes

Failover status Enabled

Current device status MASTER

Virtual IP Address 192.168.0.250

Master IP 192.168.0.139

Backup IP 192.168.0.140

Enable database replication

Please note:

- Failover (HA) cluster requires 2 devices for operation
- Both devices must have the same failover configuration
- Virtual IP address must be in the same subnet as the device's physical IP address
- Result of a proper work of a failover cluster is one MASTER device, and one BACKUP device
- You can enable database replication to synchronize Folders/Phonebook contacts/Users from MASTER to BACKUP node
- Enabling DB replication will allow external database access for IP addresses of master/backup nodes

Save

Screenshot from "General Settings-Failover"

Database replication between nodes allows to automatically replicate database content from MASTER to BACKUP (one direction only). In the current software version, the following content is replicated: Folders (with messages), Phonebook contacts, Users. Please note that this feature is only available in devices with hardware Rev.2 and higher.

After correct configuration of the HA-cluster **you should access the cluster via its Virtual IP address.**

SNMP-monitoring of HA-cluster

Failover feature uses KEEPALIVED-MIB for SNMP monitoring.

EXAMPLE OF READING **DEVICE CLUSTER STATE VALUE** USING NET-SNMP LIBRARY

a) Command for reading the result value:

```
snmpget -v 2c -c public ip-of-smseagle .1.3.6.1.4.1.9586.100.5.2.3.1.4.1
```

Result:

```
KEEPALIVED-MIB::vrrpInstanceState.1 = INTEGER: master(2)
```

Comment: Current device state is master

SMSEAGLE PLUGINS

Basic features of SMSEagle software are extended by plugins that provide extra features to the software. Below you will find a description of plugins available in each SMSEagle device. All plugins are an integral part of SMSEagle software. That means that all described plugins are installed in a standard software of SMSEagle device and are available for free.

Network Monitoring plugin

SMSEagle is equipped with network monitoring features. With that features you can monitor any device or service that operates ICMP, TCP, UDP or SNMP protocol. SMSEagle Network Monitoring plugin sequentially controls availability of defined hosts/services in Network Monitoring feature and sends defined SMS alert when host/service is unavailable/goes back to life or when SNMP return value reaches required criteria. Below you will find a brief overview of plugin capabilities.

Control status of all your defined tasks

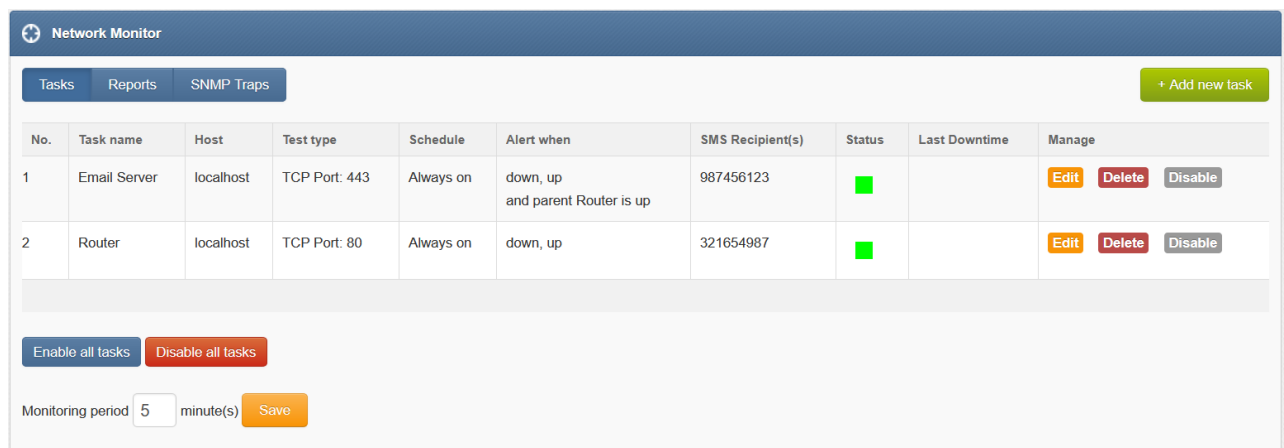

The screenshot shows the 'Network Monitor' interface. It has a header with a refresh icon and the title 'Network Monitor'. Below the header are three tabs: 'Tasks', 'Reports', and 'SNMP Traps'. A green '+ Add new task' button is in the top right. The main area contains a table with the following columns: No., Task name, Host, Test type, Schedule, Alert when, SMS Recipient(s), Status, Last Downtime, and Manage. There are two rows of tasks. Below the table are buttons for 'Enable all tasks' and 'Disable all tasks'. At the bottom, there is a 'Monitoring period' input field set to '5' minutes, with a 'Save' button.

No.	Task name	Host	Test type	Schedule	Alert when	SMS Recipient(s)	Status	Last Downtime	Manage
1	Email Server	localhost	TCP Port: 443	Always on	down, up and parent Router is up	987456123	■		Edit Delete Disable
2	Router	localhost	TCP Port: 80	Always on	down, up	321654987	■		Edit Delete Disable

- see a settings' overview for all of your tasks
- check which server/service is currently unavailable
- see when a specific server/service was last down (last downtime)
- check what happened at last downtime (see server/service response)
- edit/delete your tasks
- disable tasks when needed (e.g. when doing a machine upgrades)

Define what you want to monitor in each task

The screenshot shows the 'Add Monitoring Task' form with the following fields and values:

- Task name: Email Server
- Parent task: Router
- Host: localhost (IP address or Hostname)
- Test type: ICMP (ping), port TCP, port UDP, SNMP
- Port number: 443
- Connect Timeout: 30 (In seconds, increase this for busy servers)

- choose a name for the task
- set parent task. If parent task is defined, network monitor will monitor child task health only if parent task is healthy
- enter a host (IP address or Hostname)
- choose ICMP (ping) to monitor a server with ICMP protocol
- or PORT (TCP/UDP) to monitor your service on a selected port (SMSEagle will check if port is open)
- or SNMP to monitor objects via SNMP protocol (supported return types: numeric, string)
- increase a default timeout value for busy servers (by default we set it to 30 seconds)
- test the connection of server

Define a schedule

The screenshot shows the 'Add Monitoring Task' form with the following fields and values:

- Number of requests: 3
- Connect Timeout: 30 (In seconds, increase this for busy servers)
- Test connection:
- Active: Always on, Disable between specified hours
- Disable from: 00 : 00 to: 00 : 00
- SMS Recipient(s): Phonebook public group(s), Single number(s)
- 123456789
- SMS sent when: host/service goes down, host/service goes up after failure

- choose if task should be always enabled...
- ...or disable it at chosen times
(during a night, when a machine goes through planned restarts, during resource intensive backups, etc.)
- enter a phone number or choose a group of users to send your SMS alert to
- select when to send SMS alert (when host/service goes down, when host/service goes up after failure)

Define a SMS alert message

SMS Text:
when service goes
down

This is automatic alert from SMSEagle Network-monitor. Alert from task: {TASKNAME}. Error was: {RESPONSE} Time generated: {TIMESTAMP}

Placeholders for SMS Text:

- {TASKNAME} - name of monitoring task
- {HOST} - host
- {RESPONSE} - error response from server/service
- {TIMESTAMP} - error timestamp

Define your SMS messages when host or service becomes unavailable/comes back to life. Choose field placeholders for your SMS text:

- {TASKNAME} – puts a taskname inside SMS text
- {HOST} – hostname or IP address
- {RESPONSE} – message received (in case of no response from server/service)
- {TIMESTAMP} – timestamp of an error

Receive SMS alerts

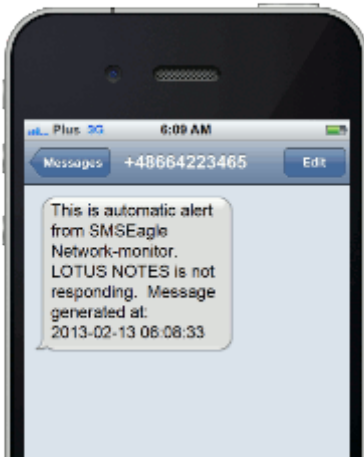

- be alerted when your services/servers go down (or go up after failure)
- give yourself a chance to react quickly

MONITORING FREQUENCY

Monitoring tasks are performed in a parallel mode. Software automatically optimizes number of parallel tasks and frequency of tasks taking into account the performance of the device and adjusts monitoring period when needed.

You can manually increase/decrease monitoring period in Network Monitor settings:

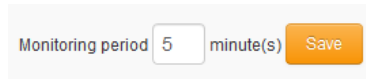

Monitoring period minute(s)

If monitoring period value is too small (there are too many monitoring tasks to perform in parallel), the software will adjust the value to ensure optimal workload and performance of your device.

REPORTS

This tab allows you to view reports of task errors in the Network Monitor for a selected period of time.

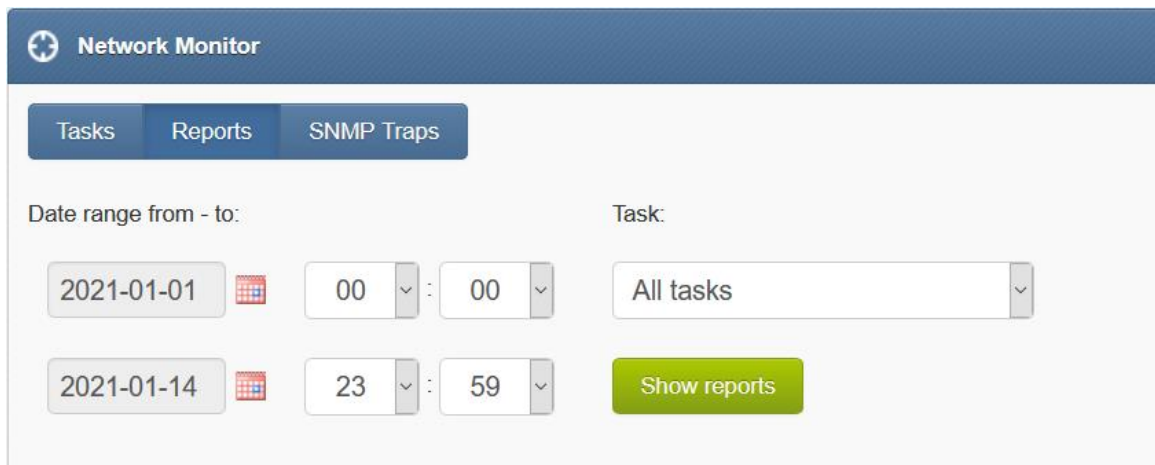

Network Monitor

Tasks Reports **SNMP Traps**

Date range from - to:

2021-01-01 00 : 00

2021-01-14 23 : 59

Task: All tasks

Show reports

Screenshot from Network Monitor > Reports window.

SNMP TRAPS

SNMP trap is a popular mechanism used to manage and monitor devices' activities across a small or a global network. What makes the Trap unique is that they are triggered instantaneously by an agent, rather than waiting for a status request from SNMP get query.



Network Monitor

Tasks Reports **SNMP Traps**

No.	Rule Name	Rule Condition	SMS Recipient(s)	Manage
1	Device #1 power on	When incoming trap contains Object ID SNMPv2-MIB::snmpTrapOID.0 if SNMP return value is contains coldStart	sample contact	<input type="button" value="Edit"/> <input type="button" value="Delete"/> <input type="button" value="Disable"/>
2	Signal quality	When request comes from IP 192.168.8.19 When incoming trap contains Object ID GSM_Signal if SNMP return value is lower than 20	sample contact	<input type="button" value="Edit"/> <input type="button" value="Delete"/> <input type="button" value="Disable"/>

SNMP Traps daemon Community

Screenshot from Network Monitor > SNMP TRAPS window.

Screenshot from Network Monitor > SNMP TRAPS Add or Edit window.

Email to SMS plugin

Email to SMS plugin allows you to convert an email to SMS message.

BASIC USAGE

If the plugin is enabled, email sent to the email address:

PHONE_NUMBER@IP_ADDRESS_OF_SMSEAGLE will be converted to SMS message.

Where:

PHONE_NUMBER - is a destination phone number

IP_ADDRESS_OF_SMSEAGLE - is the IP address of your device.

The text of the email is the text of the SMS message (optionally you can append email subject at the beginning of SMS message).

Example: email message sent to the address: 123456789@192.168.0.101 will be converted to SMS message and delivered to phone number 123456789.

SEND TO USERNAME/GROUP

Email sent to the email address:

NAME_IN_PHONEBOOK@IP_ADDRESS_OF_SMSEAGLE will be converted to SMS message and will be sent to a user or users' group from SMSEagle's phonebook.

Where:

NAME_IN_PHONEBOOK - is a username or group name (must be a public group) from SMSEagle's phonebook

IP_ADDRESS_OF_SMSEAGLE - is the IP address of your device.

The text of the email is the text of the SMS message (optionally you can append email subject at the beginning of SMS message).

Example: email message sent to the address: db-admins@192.168.0.101 will be converted to SMS message and delivered to all members of db-admin group. The db-admin group must be defined in your SMSEagle phonebook.

SEND TO LDAP CONTACTS

If your company uses LDAP (Active Directory or OpenLDAP) for contacts management, you may use LDAP Contacts to send email to SMS text message.

Example: email message sent to the address: myldap-admins1@192.168.0.101 will be converted to SMS message and delivered to all members of myldap-admins1 group. The myldap-admins1 group must be defined in your LDAP directory and LDAP plugin must be configured on your SMSEagle device.

USING FQDN IN EMAIL ADDRESS

It is also possible to use Fully Qualified Domain Name in an email address sent to SMSEagle box (eg.: 123456789@mydomain.com). Please refer to our FAQ article: [How do I configure Email2SMS plugin to accept FQDN email addresses](#) for more details.

EMAIL SUBJECT - ADDITIONAL PARAMETERS (OPTIONAL)

It is possible to set additional flags for single converted message using email subject. Currently the following flags are available:

- date - date and time in format YYYYmmDDHHMM (YYYY – year, mm – month, DD – day, HH – hour, MM – minute). If this parameter is not null SMS will be scheduled for sending at the given date and time
- modem_no - sets sending modem number (available only for multimodem devices)

If you send email with subject containing FLAG=VALUE the flag will be set for this particular email2SMS message.

Example 1: email message with subject containing **modem_no=2** will be converted to SMS message and sent via modem number 2.

Example 2: email message with subject containing **date=201801010005&modem_no=2** will be converted to SMS message and sent on 2018-01-01 00:05 via modem number 2.

PLUGIN CONFIGURATION

Plugin "Email To SMS" allows to add many forwarding rules. Each rule can be enabled or disabled by user.

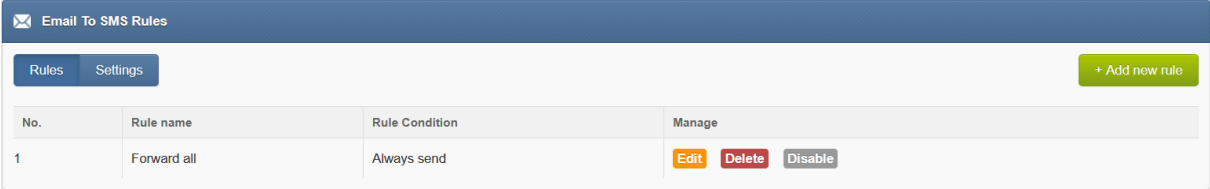

Screenshot from Email To SMS > Rules window

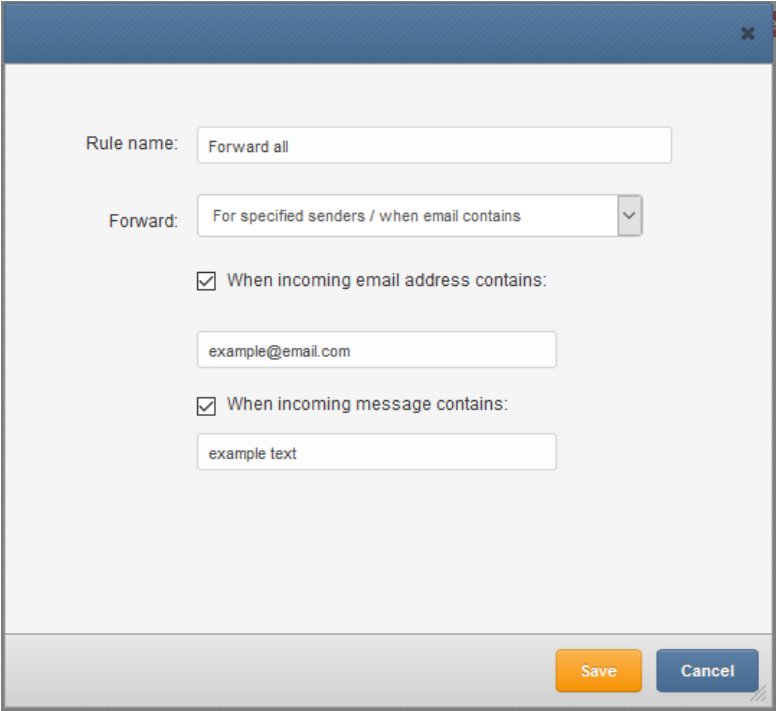

Screenshot from Email to SMS > Add new rule

- You can name your rule
- You can set forwarding to Always or For specified senders / when email contains

Screenshot from Email to SMS settings

- if you want to use the plugin, set 'Email2SMS active' to 'Yes'
- if you want to include a subject of an email in SMS message, set 'What to do with email subject' setting to 'Include in SMS'. The email subject will be appended at the beginning of SMS message
- if you want to use user authentication, set 'What to do with email subject' setting to 'Use for authentication'. If user authentication is enabled, provide in a subject of an email your login and password in the following form: login=john&pass=doe OR provide API access token in the following form: access_token=token
- if you want to include only a subject of an email in SMS message, set 'What to do with email subject' setting to 'Send only subject without email body'. Only the email subject will be inserted in the SMS message
- the text of an email will be cropped to the value 'Maximum number of characters. Maximum allowed length of SMS message is 1300 characters
- if you want to include in SMS message special national characters (like äääöö 我) set "Unicode encoding of SMS text" to "Yes"
- if you want to send as MMS you can set as always or only when an email contains an attachment
- Choose if you want to use contacts from LDAP directory (Yes/No). LDAP plugin must be first configured to use this feature
- If you enabled contacts from LDAP, define Phone number for LDAP errors. Alerts about errors with LDAP connection will be sent to this phone number after 3 unsuccessful LDAP connection attempts. Leave this field empty for not alerts

Email to SMS Poller

Email2SMS Poller is an alternative for Email2SMS plugin for converting emails to SMS messages. This plugin should be used when you need to fetch emails from an existing mailbox on your mail server. The Email2SMS Poller plugin connects to a configured email account and polls it in specified periods of time for new emails. Once a new email is received, it is automatically converted to an SMS message.

The plugin supports POP3 and IMAP accounts.

To send an SMS using Email2SMS Poller you have to send an email to a specified email account, with the email subject containing a mobile number (or multiple phone numbers separated with comma) or phonebook contact/group name.

BASIC EXAMPLE

For example, such email message:

TO: smseagle@mycompany.com

FROM: john.doe@mycompany.com

SUBJECT: +48333444555

BODY: Hello world!

In this case SMSEagle gateway will fetch an incoming email from smseagle@mycompany.com account and send its body as SMS message to +48333444555 mobile number.

SEND TO USERNAME/GROUP

If you want to send SMS to a contact or group from SMSEagle phonebook, put the contact/group name in SUBJECT field.

Notice:

Messages that are processed by Email2SMS Poller (but not deleted) are marked in the mailbox as read. Software is based on flagging messages- Read/Unread. Marking a read message in the mailbox as unread will result in being processed again by Email2SMS Poller. We suggest using a separate email account to avoid situation with resending the same message (marking unread already processed read message).

PLUGIN CONFIGURATION

Plugin "Email To SMS Poller" allows to add many forwarding rules. Each rule can be enabled or disabled by user.

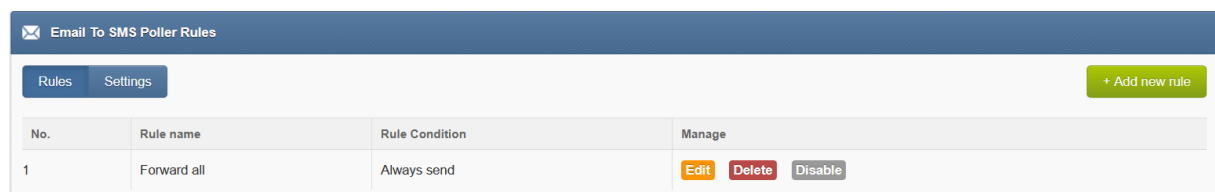

No.	Rule name	Rule Condition	Manage
1	Forward all	Always send	Edit Delete Disable

Screenshot from Email to SMS Poller Rules

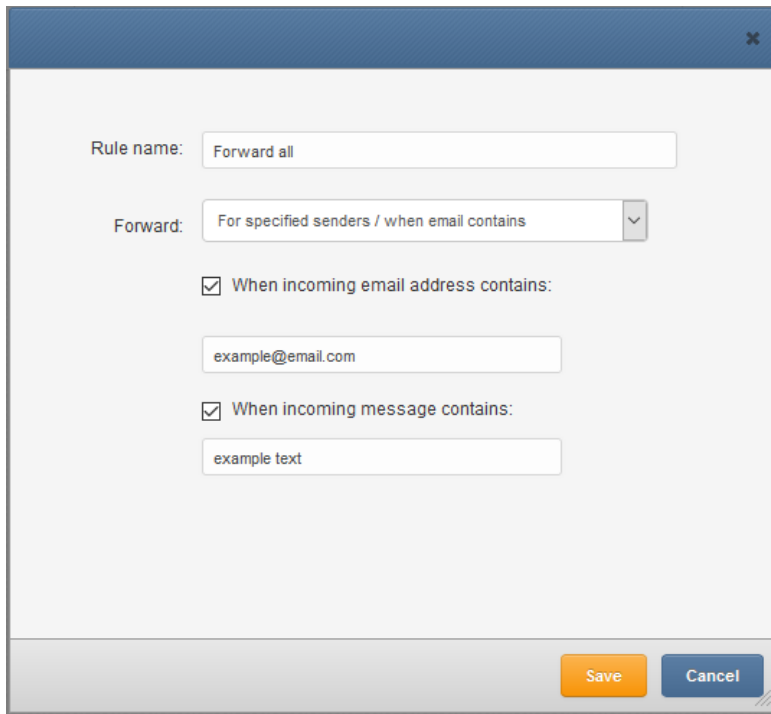

Rule name: Forward all

Forward: For specified senders / when email contains

When incoming email address contains:
example@email.com

When incoming message contains:
example text

Save Cancel

Screenshot from Email to SMS Poller > Add new rule

- You can name your rule
- You can set forwarding to Always or For specified senders / when email contains

Screenshot from Email to SMS Poller settings

- if you want to use the plugin, set 'Enable Email2SMS Poller' to 'Yes'
- Set email fetching interval (in seconds)
- the text of an email will be cropped to the value 'Maximum number of characters. Maximum allowed length of SMS message is 1300 characters.
- If you want to include special national characters, enable "Unicode encoding of SMS text"
- Choose protocol from IMAP or POP3
- Provide mailbox configuration (host, port, user, password, encryption settings)
- If you want to delete emails from the mailbox after they are fetched by Email2SMS Poller, please mark "Delete emails from server after processing"
- If you want to send as MMS, select always or only when email contains an attachment

SMS to Email plugin

SMS to Email plugin allows you to forward incoming SMS messages to email address.

The plugin can be used in two modes:

- a. forwarding of incoming SMS to email of last sender (so called **Two-way Email2SMS & SMS2Email**)
In this mode, when SMSEagle receives incoming SMS, it checks if earlier anyone was sending SMS to the number from incoming SMS using Emal2SMS. If last sender is found, the incoming SMS is forwarded to the email address of last sender. If no last sender is found, then the incoming message is forwarded to a default email address given in plugin settings.
- b. It forwards all the incoming messages to one fixed email address.
In this mode incoming SMS messages are forwarded to always the same email address.

Plugin uses an external SMTP server for sending emails.

PLUGIN CONFIGURATION

Plugin "SMS To Email" allows to add many forwarding rules. Each rule can be enabled or disabled by user.

No.	Rule name	Rule Condition	Send to	Manage
1	Default rule	Always forward	contact@example.com	Edit Delete Disable

Screenshot from SMS to Email > Rules

Screenshot from SMS to Email > Rules > Add or Edit rule

In the rule definition you may choose to forward all incoming messages or just messages from specified senders/with specific text.

Screenshot of the SMS to Email Settings configuration page. The page shows fields for SMTP Host (mail.example.com), SMTP Port (587), SMTP Connection encryption (none), Username (user), Password (masked), and Sender email (user@example.com). There is also a checkbox for saving debug information in the system log.

Screenshot from SMS to Email settings

- enter SMTP configuration for your SMTP server that will be used for sending emails

EMAIL TEXT FROM PLUGIN

Email body from SMS To Email plugin contains:

- phone number from incoming SMS (and phonebook contact name if found)
- Date, time when SMS is received
- SMS message

Example email text sent from plugin:

From: +483334455 (John Doe)

Received: 2017-06-01 14:38:12

Message: My SMS message

SMS Forward

The plugin “SMS forward” allows to forward incoming SMS messages to one/may recipients according to defined rules.

PLUGIN CONFIGURATION

Plugin “SMS Forward” allows to add many forwarding rules. Each rule can be enabled or disabled by user.

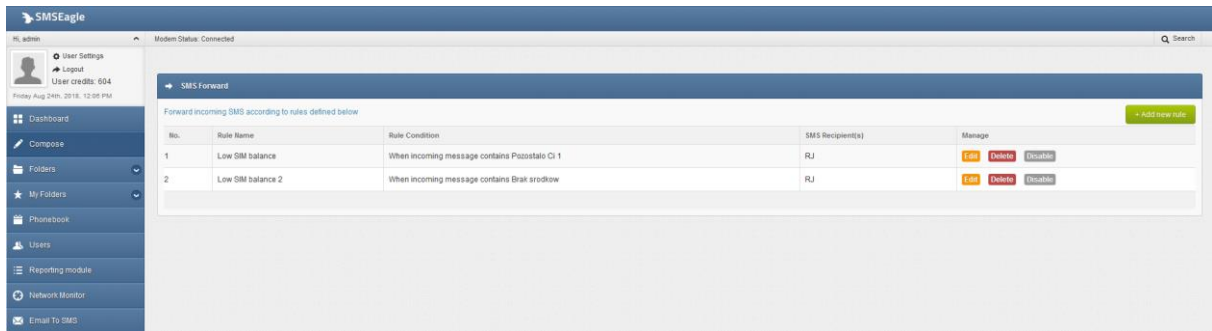

Screenshot from plugin main window

For each rule user can define:

- When incoming SMS should be forwarded (Rule type) and to what number(s) the message should be forwarded (SMS Recipient).
- Whether or not include in SMS a sender number from which original SMS came from.
- When defining a rule user can choose SMS recipient (who gets the forwarded SMS). It can be either phone number or name of group from phonebook.
- User may define many forwarding rules in the plugin.
- Each rule is processed independently.
- There is a possibility to enable/disable each rule.

Screenshot form "Add/edit forwarding rule"

Callback URL plugin

Callback URL plugin allows you to forward incoming SMS message to a defined URL address. If the plugin is enabled, on each incoming SMS message SMSEagle will trigger HTTP(S) request to a defined URL. HTTP(S) request can be of type GET or POST.

PLUGIN CONFIGURATION

Plugin "Callback URL" allows to add unlimited number of rules. Each rule can be enabled or disabled by user.

No.	Rule name	Send callback when	Manage
1	Test 1	Always send	Edit Delete Disable
2	Test 2	Always send	Edit Delete Disable

Parameter description:
 The request sent via a GET/POST to your URL have the following parameters:
sender: Sender number
timestamp: Time when SMSEagle received the message in the following format YYYYmmdd#hiss (example: 20140531092257)
text: Content of the SMS message
text_binary: Binary content of SMS message
msid: SMSEagle message id
modemno: Modem number on which incoming message was received
oid: Value of OID identifier assigned to outgoing message with matching phone number (optional)
apikey: API key of your service (optional)

SMSEagle will be expecting HTTP response: **200 [OK]**

Request string example for HTTP GET:
 ?sender=4860112313×tamp=20140531092257&msid=431&modemno=1&text=This+is+an+incoming+message

Retry interval after failed request (in minutes) | 2 | Open

Screenshot from Callback URL settings

For each new rule user has to fill in the requested fields:

- 'URL' field defines remote address of your callback script
- 'Test URL' button allows to test whether your Callback URL configuration is correct. SMSEagle will make a callback request with test parameters and will verify the response of remote server
- 'URL method' allows to choose whether callback to your URL is done with HTTP(S) GET or POST method
- "Send request when" defines if the request is always sent, sent only when SMS sender belongs to a given contact/group or only when incoming message contains a given character string
- Optionally you can define "API key of your service" value. This will be passed to your callback URL in parameter 'apikey'. If you leave the field blank, 'apikey' parameter will not be passed to your callback URL
- User may also choose whether to enable support of self-signed SSL certificate

Add or edit Callback URL rule

Rule name:

URL:

URL method:

Send request when:

API key of your service:

You can set additional API key that is expected by your service (to increase security)

Allow self-signed SSL certificate:
 SSL certificate
 Verify peer
 Verify peer name

After sending HTTP(S) GET/POST request to your callback URL, SMSEagle will be expecting HTTP response: 200 [OK]. If other or no response is received from your callback URL, SMSEagle will keep retrying every X minute for 24 hours. Retry interval can be set in main plugin Window:

Retry interval after failed request (in minutes)

Periodic SMS

The plugin “Periodic SMS” allows to send SMS messages or USSD codes at a desired time interval. User may define many sending rules, and each rule will be processed independently.

PLUGIN CONFIGURATION

Plugin “Periodic SMS” allows to add many sending rules. Each rule can be enabled or disabled by user.

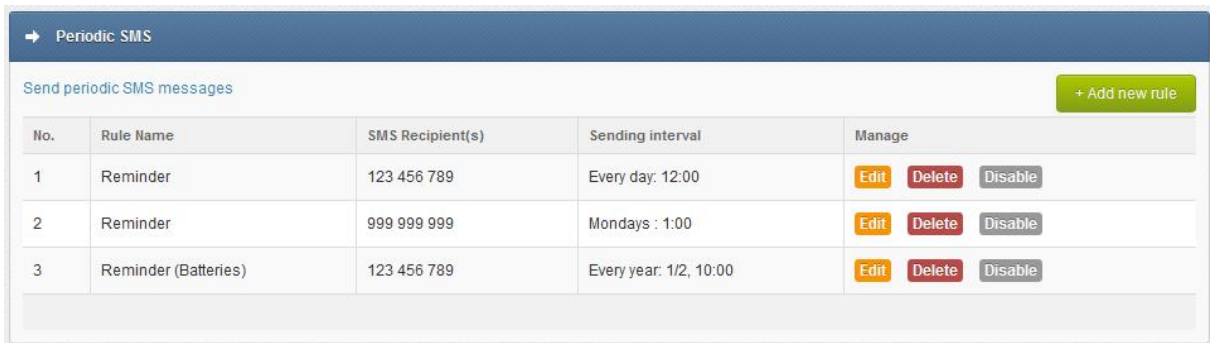

The screenshot shows the 'Periodic SMS' configuration window. It features a header with a back arrow and the title 'Periodic SMS'. Below the header, there is a section titled 'Send periodic SMS messages' with a '+ Add new rule' button. The main content is a table with the following data:

No.	Rule Name	SMS Recipient(s)	Sending interval	Manage
1	Reminder	123 456 789	Every day: 12:00	Edit Delete Disable
2	Reminder	999 999 999	Mondays : 1:00	Edit Delete Disable
3	Reminder (Batteries)	123 456 789	Every year: 1/2, 10:00	Edit Delete Disable

Screenshot from main plugin window

For each rule the user can define:

- The rule name
- Sending interval (Hourly, Daily, Weekly, Monthly or Annually)
- Message type (SMS, USSD Code)
- The content of the SMS text
- The recipients (phone number(s) separated with comma or group(s) from phonebook)

Screenshot from "Add new rule" window

Autoreply plugin

Plugin allows to automatically respond to each received message with defined text response.

PLUGIN CONFIGURATION

Plugin "Autoreply" allows to add many autoreply rules. Each rule can be enabled or disabled by user.

No	Rule name	Send autoreply message when	Manage
1	default rule	Always send	Edit Delete Disable
2	Phonebook contact rule	When incoming SMS comes from sample contact	Edit Delete Disable
3	Yes rule	When incoming SMS text contains YES	Edit Delete Disable

Sending limit: Always send automatic replies Save

Screenshot from plugin main window

For each rule user can define:

- When autoreply message should be sent:

- always,
- when incoming message contains defined text,
- and/or when message sender belongs to Phonebook contact/group
- If autoreply message text should be sent as Unicode characters

Plugin also allows to define sending limit for autoreply messages. It is possible to set limitation of max 5 messages / 10 minutes / phone number.

The screenshot shows a web-based configuration interface for an autoreply rule. At the top, there is a 'Sending limit' dropdown menu set to 'Always send automatic replies' and a 'Save' button. Below this is a text input field containing 'Limit sending to max 5 messages/10 minutes/phone number'. The main dialog box is titled 'Add or edit Autoreply rule' and contains the following fields:

- Rule name:** A text input field containing 'test'.
- Send autoreply when:** A dropdown menu set to 'From specified senders / with specified message'.
- When incoming SMS comes from:** A checked checkbox with a text input field containing 'work'.
- When incoming SMS text contains:** A checked checkbox with a text input field containing 'alert'.
- Autoreply message:** A text area containing the message: 'Thank you for your message. Our representative will contact you shortly'.
- Send as Unicode:** An unchecked checkbox.

At the bottom of the dialog, there are 'Save' and 'Cancel' buttons.

Screenshot form "Add/edit autoreply rule"

Digital input/output

The NXS- family of SMSEagle devices is equipped with digital inputs (DI) and digital outputs (DO). The digital inputs can be used to receive signals from outside sensors or devices and automatically trigger sending of SMS message based on input state. On the other hand, the digital outputs may be used to activate external devices connected to the outputs when certain SMS messages are received by SMSEagle.

Number of available DI/DO ports depends on hardware revision:

Port type	Hardware Rev.3	Hardware Rev.2, Rev.1
DI	4	2
DO	4	2

The logical states of inputs and outputs of SMSEagle NXS-family of devices are represented by the following states:

Logical level	Hardware Rev.3	Hardware Rev. 2, Rev.1
LOW (0)	+5 V	0 V
HIGH (1)	0 V	+5 V

USING DIGITAL OUTPUTS

From digital output, without side effects, you can directly control external circuit with a voltage not exceeding 5V and a current of max. 450mA.

But the safest form of control external circuits is using an intermediary relay with a protection diode. Usage example has been shown on the picture below.

Warning: *If you plan to use digital output with relay, it is recommended to connect a separate protection diode (a.k.a. "snubber") across the relay coil terminals as well. A diode snubber circuit can be added when ordering from some relay manufacturers. This diode is installed in the direction that does not ordinarily allow current to conduct. When current to the inductive load is rapidly interrupted, a large voltage spike is produced in the reverse direction as the inductor attempts to keep current flowing in the circuit. Placing the snubber diode in parallel with the inductive load for reversed-bias flow allows the current from the inductor to flow through the diode rather than through the switching element, dissipating the energy stored in the inductive load from its series resistance and instead goes through the much smaller resistance of the diode.*

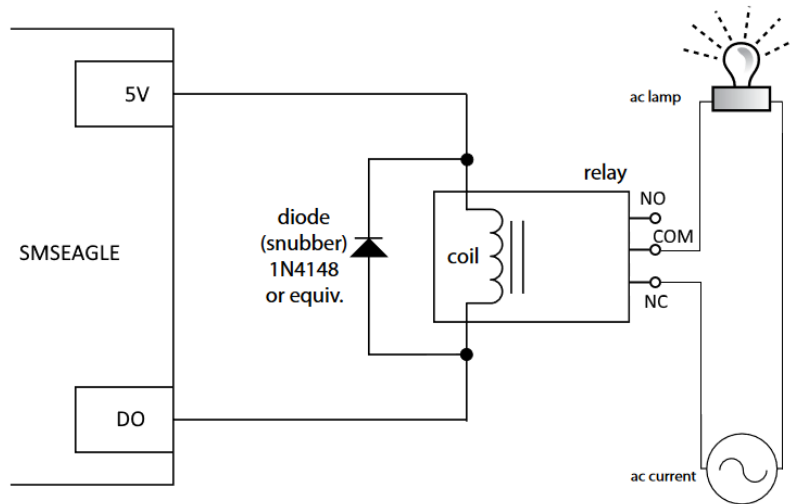

Digital Output - example of usage with external relay Digital

USING DIGITAL INPUTS

Digital inputs (DI) of SMSEagle device are of type “pull-up resistor”. This type of input is used to prevent accidental switching of digital circuits. In order to achieve it any unconnected inputs called “floating inputs” should be tied to a logic “1” or logic “0” as appropriate for the circuit. We do this by using what are commonly called Pull-up Resistors to give the input pin a defined default state, if there is nothing is connected to it. This can be observed with a voltage level of 3-5V on unconnected digital input.

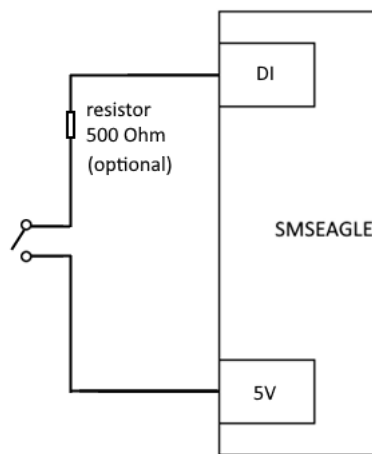

Digital Input - most simple usage. Optional 500 Ohm resistor is needed when using long cables

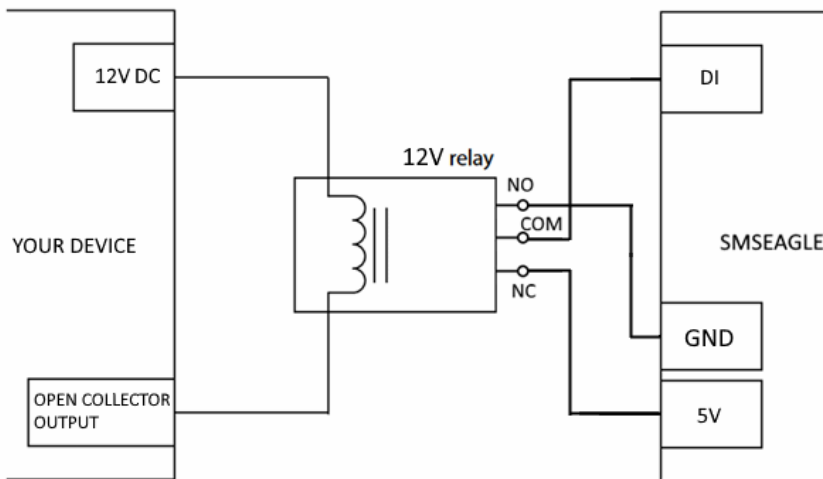

Digital Input - connection example with a device with open collector output

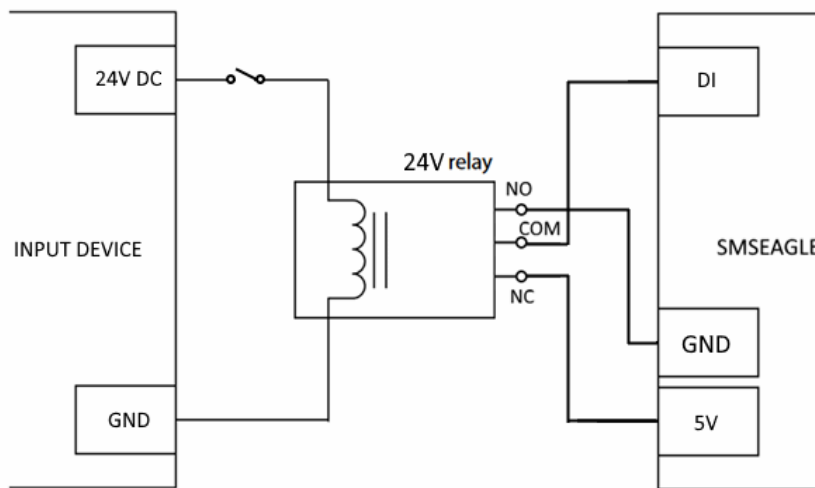

DI/DO PLUGII
The plugin "D
inputs/output

outs.

Digital Input - connection example with a device with 24V output

Plugin status: Enabled Save

Digital inputs

Input 1 signal: 0 + Add new rule
 Input 2 signal: 0

No	Rule Name	Port number	When input signal	Send to	Manage
1	Open door alert	1	1	123 456 789	Edit Delete Disable

Digital outputs

Output 1 signal: 0 + Add new rule
 Output 2 signal: 0

No	Rule Name	Port number	Rule Condition	Set signal to	Manage
1	Horn enable	1	Only when incoming SMS text contains Alert	1	Edit Delete Disable

Screenshot from plugin window

DIGITAL INPUTS

For each processing rule for digital input user can define:

- The rule name
- Port number
- State of input signal that will trigger sending of SMS message (field "When input signal")
- SMS text (field "Send SMS message")
- The recipient's name from phonebook
- Alert timeout. This value defines time between consecutive alerts. If the value is set and input is triggered several times during the timeout, only one alert message will be sent

Screenshot from digital input “Add or edit rule” window

DIGITAL OUTPUTS

For each processing rule for digital output user can define:

- The rule name
- Port number
- On what condition digital output should be set (all incoming messages, when incoming SMS comes from specified contact in phonebook or when incoming SMS text contains given value)
- State of output signal that will be triggered by incoming SMS message
- Output signal duration in seconds (0 = without time limit)
- Output signal delay before signal is set

Screenshot from digital output "Add or edit rule" window

Temperature & humidity sensor

The NXS-family of SMSEagle devices is equipped with internal temperature and humidity sensor. The DHT22 sensor allows to measure temperature with $\pm 0.5^{\circ}\text{C}$ accuracy and humidity with $\pm 2\%$ RH accuracy. The measured temperature and humidity values can be displayed in web-gui of SMSEagle and used to trigger SMS message to single/many recipients.

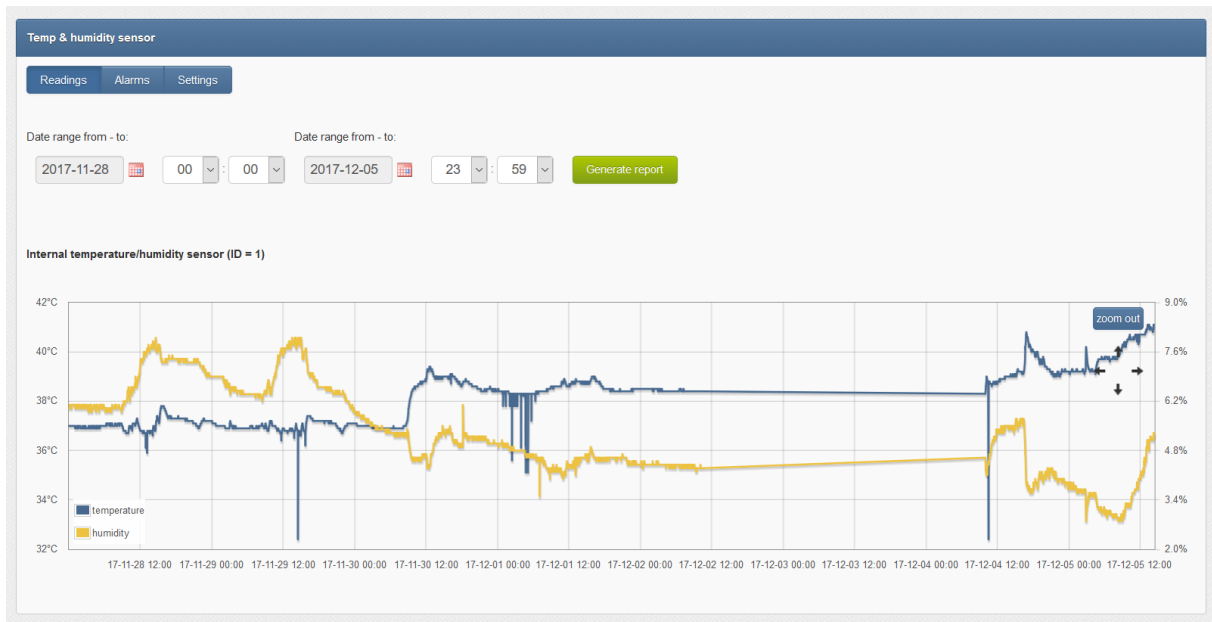

Screenshot from plugin main window

PLUGIN CONFIGURATION - ALARMS

Tab "Alarms" allows to define triggering rules for SMS alarms for temperature and humidity. User may define several processing rules.

No.	Rule name	Alert when	Send to	Man
1	Humidity alarm	humidity is lower than 30.0 %	John Kowalski	Ed
2	Temperature alarm	temperature is higher than 60.0 °C	John Doe	Ed

Screenshot from "Alarms" window

For each processing rule for digital output user can define:

- The rule name
- Sensor (currently only 1 sensor is available)
- On what condition SMS alarm should be sent (temperature/humidity is higher/lower than given value)
- SMS text
- SMS recipient: contact name or group name from Phonebook

Screenshot from "Add or edit rule" window

PLUGIN CONFIGURATION - SETTINGS

Tab "Settings" allows to control sensor settings. User may enable/disable sensor and set sensor reading period (in minutes).

Screenshot from "Settings" window

READING TEMP/HUMIDITY VIA SNMP PROTOCOL

Current temperature and humidity values from internal sensor can be also read via SNMP protocol. See chapter "**SNMP agent**" for detailed description.

LDAP plugin

The LDAP plugin allows to access Active Directory (hereinafter referred to as "AD") and read contacts and groups in SMSEagle web-GUI. The plugin can work with either Active Directory or OpenLDAP protocol type.

PLUGIN CONFIGURATION

Choose "LDAP" from left side menu in SMSEagle web-GUI to access plugin configuration. After enabling the plugin, user needs to fill in all requested fields according to AD settings.

In the "AD phone attribute" field user needs to choose which phone attribute from AD will be shown in SMSEagle web-gui.

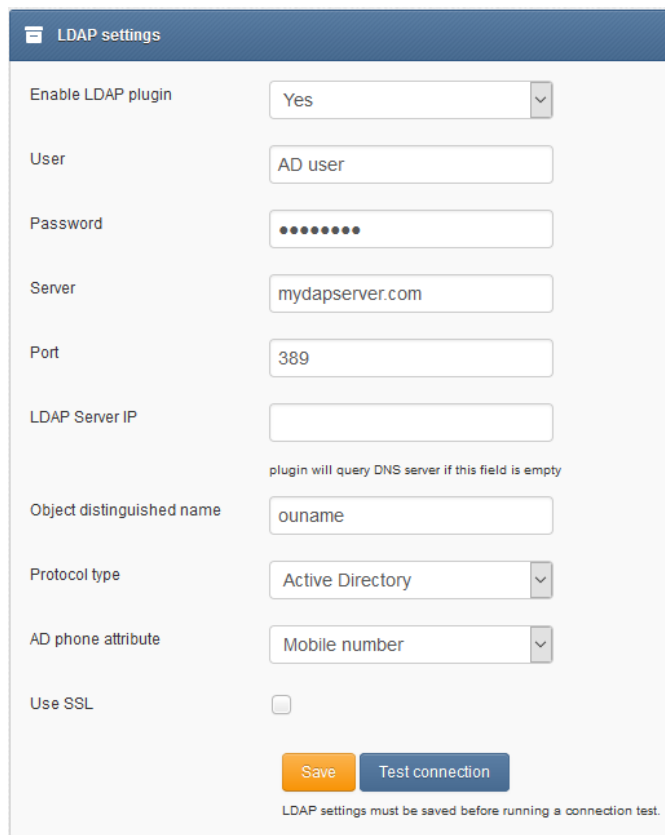

The screenshot shows the "LDAP settings" configuration window. It contains the following fields and controls:

- Enable LDAP plugin:** A dropdown menu set to "Yes".
- User:** A text input field containing "AD user".
- Password:** A password input field with masked characters (dots).
- Server:** A text input field containing "mydapserver.com".
- Port:** A text input field containing "389".
- LDAP Server IP:** An empty text input field. Below it, a note states: "plugin will query DNS server if this field is empty".
- Object distinguished name:** A text input field containing "ouname".
- Protocol type:** A dropdown menu set to "Active Directory".
- AD phone attribute:** A dropdown menu set to "Mobile number".
- Use SSL:** An unchecked checkbox.
- Buttons:** "Save" (orange) and "Test connection" (blue).
- Footer:** A note stating "LDAP settings must be saved before running a connection test."

Screenshot from "LDAP settings" window

Click "Save" and "Test connection" to make sure that SMSEagle is connected with AD server.

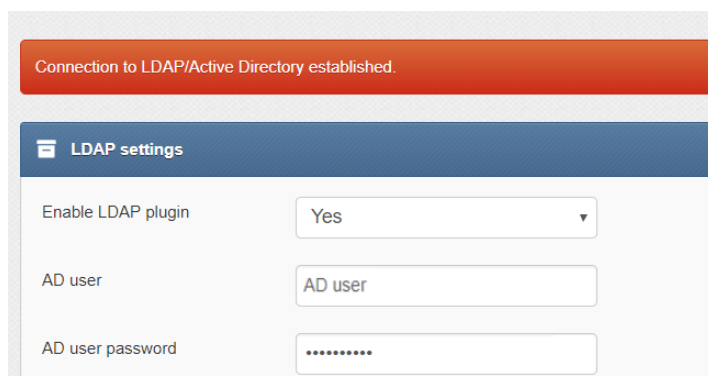

This screenshot shows the "LDAP settings" window after a successful connection. At the top, a red notification bar displays the message: "Connection to LDAP/Active Directory established." Below this, the configuration fields are visible, with the following values:

- Enable LDAP plugin:** "Yes"
- AD user:** "AD user"
- AD user password:** Masked with dots

Screenshot showing successful connection to AD server.

With connection established, AD contacts/groups suggestions are shown in selected modules of web-gui. Start typing any part of contact/group name or number to show AD contact suggestions.

Type "LDAP" (case sensitive) to check all contacts listed in AD directory.

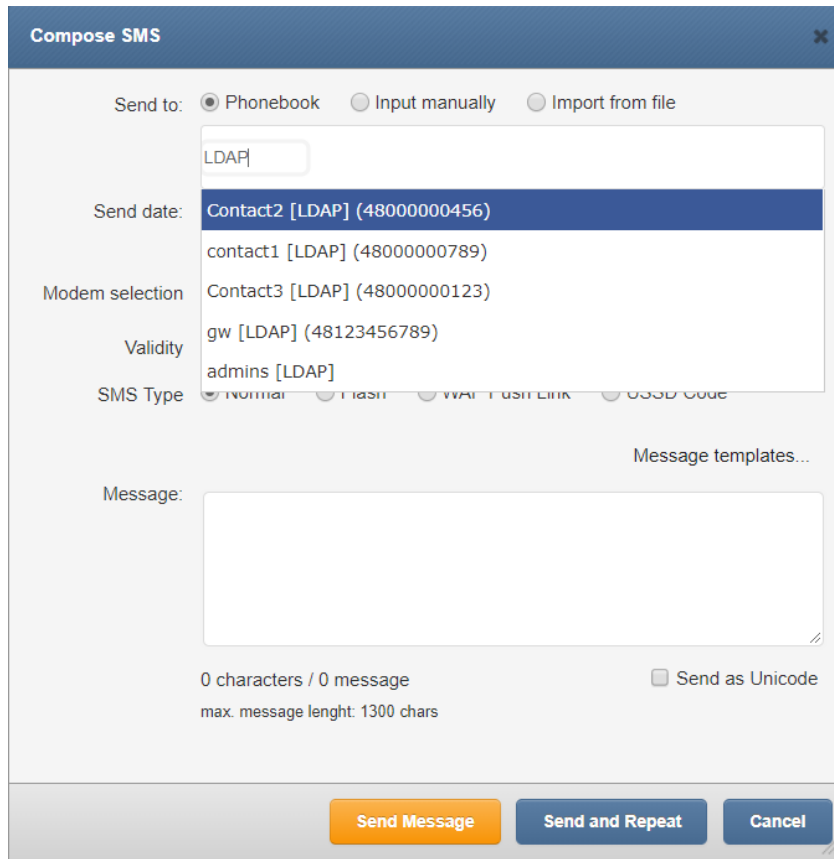

The screenshot shows the 'Compose SMS' interface. At the top, there are three radio buttons for 'Send to': 'Phonebook' (selected), 'Input manually', and 'Import from file'. Below this is a search input field containing 'LDAP'. A dropdown menu is open, displaying a list of LDAP contacts with their phone numbers: 'Contact2 [LDAP] (48000000456)', 'contact1 [LDAP] (48000000789)', 'Contact3 [LDAP] (48000000123)', 'gw [LDAP] (48123456789)', and 'admins [LDAP]'. Other fields include 'Send date', 'Modem selection', 'Validity', and 'SMS Type' (with radio buttons for 'Normal', 'Flash', 'WAP Push Link', and 'USSD Code'). A 'Message' text area is at the bottom, with a character count of '0 characters / 0 message' and a 'max. message length: 1300 chars'. There are three buttons at the bottom: 'Send Message', 'Send and Repeat', and 'Cancel'.

Screenshot from "Compose" module with LDAP connection enabled

LDAP directory suggestions can be used in "Compose", "Autoreply" and "Digital input/output" modules.

Blacklist

This feature allows you to add a number to a Blacklist. When a number is on this list, the device automatically blocks any sent and received SMS from the number as well as deletes the messages from your inbox.

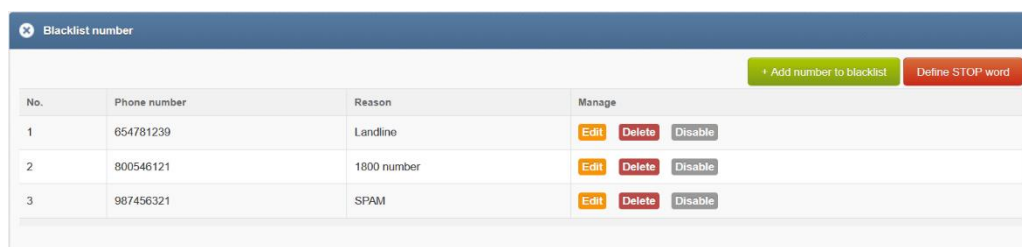

The screenshot shows the 'Blacklist number' interface. At the top right, there are two buttons: '+ Add number to blacklist' and 'Define STOP word'. Below is a table with the following data:

No.	Phone number	Reason	Manage
1	654781239	Landline	Edit Delete Disable
2	800546121	1800 number	Edit Delete Disable
3	987456321	SPAM	Edit Delete Disable

Screenshot from "Blacklist" feature

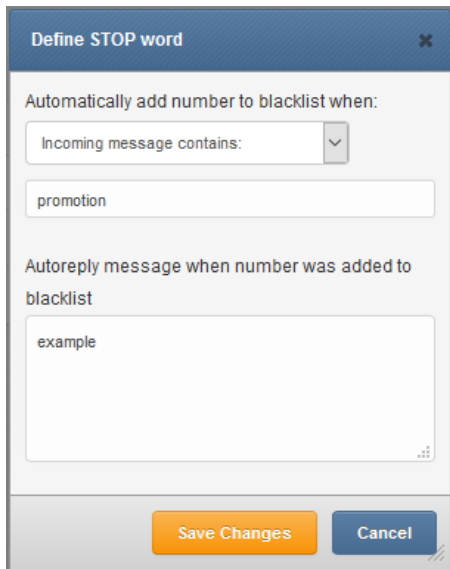

Screenshot from Blacklist > Define STOP word feature

- You may defined a STOP keyword. When incoming message contains the keyword then the sender number will be automatically added to blacklist.

SMSEAGLE API

SMSEagle has powerful built-in REST API functionalities. API is dedicated for integration of SMSEagle with any external system or application. Below you will find a detailed description of API functionalities.

SMSEagle API supports both HTTP and HTTPS protocol.

For your convenience sample usage of SMSEagle's API in most popular programming languages are available at: <https://www.smseagle.eu/code-samples/>

0. API Authentication

Before you can start using API, first you need to enable API access.

- a) go to WebGUI > Users
- b) create a new User with access level "User", set "Access to API" to "On" (optionally you may limit access only to selected API methods)
- c) choose API authentication method. This can be either:
 - access_token (*recommended solution*)
Edit your API User > check "Enable token" and generate new access token. The token will be used to authenticate in API methods
or
 - b) login and password
Use your API User credentials to authenticate in API methods

EXAMPLES OF AUTHENTICATION:

- with access token
`https://url-of-smseagle/http_api/send_sms?access_token=0001gOjCO1MH8F2q`
- with login and password
`https://url-of-smseagle/http_api/send_sms?login=john&pass=doe`

API credentials created here will be used to authenticate in all API methods (see descriptions below).

1. Send SMS: HTTP GET method

HTTP GET METHOD:

`https://url-of-smseagle/http_api/send_sms`

PARAMETERS:

Parameter	Description
access_token	authentication access token (see details in point API Authentication)
login	your user to login to SMSEagle (see details in point API Authentication)
pass	your password to login to SMSEagle
to	recipient telephone number (or numbers separated with comma)

message	your SMS message
date	<i>(optional parameter)</i> date and time in format YYYYmmDDHHMM (YYYY – year, mm – month, DD – day, HH – hour, MM – minute). If this parameter is not null SMS will be scheduled for sending at the given date and time
highpriority	<i>(optional parameter)</i> 0 = normal priority, 1 = SMS will have higher priority in Outbox queue when processed by GSM-modem
unicode	<i>(optional parameter)</i> 0 = no Unicode encoding (default), 1 = SMS will be encoded using Unicode (you can send national characters)
flash	<i>(optional parameter)</i> 0 = normal SMS (default), 1 = SMS will be sent as flash message
oid	<i>(optional parameter)</i> This attribute specifies a user-defined unique ID that is assigned to a message-recipient pair. The oid is a varchar (36) that uniquely identifies a message sent to a particular recipient (particular phone number). The value of this ID allows client applications to match incoming reply messages to outgoing messages. If no oid was assigned to the outgoing message this attribute will have a value of null for incoming message. The oid value will be automatically assigned to incoming message only if incoming phone number matches exactly the phone number (including country code) from outgoing message.
modem_no	<i>(optional parameter)</i> sending modem number (only for multimodem devices)
responsetype	<i>(optional parameter)</i> text = format response as text (default), xml = format response as XML object
validity	<i>(optional parameter)</i> How long will be the message valid. If message expires before it is received by a phone, the message will be discarded by cellular network. Acceptable parameter values: 5m, 10m, 30m, 1h, 2h, 4h, 12h, 1d, 2d, 5d, 1w, 2w, 4w, max. Default value: max
send_after	<i>(optional parameter)</i> send a message after specified time. It can be used to prevent messages from being sent at night. Format: HH:MM:SS (HH – hour, MM – minute, SS – second)
send_before	<i>(optional parameter)</i> send a message before specified time. It can be used to prevent messages from being sent at night. Format: HH:MM:SS (HH – hour, MM – minute, SS – second)
test	<i>(optional parameter)</i> 1 = simulate message sending. Messages with that parameter will not be added to outbox and they will return ID = 0

EXAMPLES:

```
https://url-of-smseagle/http_api/send_sms?
access_token=0005gOjCO1MH8F2x&to=1234567&message=mymessage
```

```
https://url-of-smseagle/http_api/send_sms?
access_token=0005gOjCO1MH8F2x&to=1234567&message=mymessage&date=20140115213
2
```

https://url-of-smseagle/http_api/send_sms?
access_token=0005gOjCO1MH8F2x&to=1234567&message=mymessage&highpriority=1

RESPONSE:

Response: **OK; ID=[ID of message in outbox]**

Sample response: OK; ID=297

Response (when wrong logindata): **Invalid login or password**

Response (when wrong access token): **Invalid access token**

Response (when wrong parameters): **Wrong parameters**

RESPONSE (XML):

Response:

```
<xml>  
  <message_id>[ID of message in outbox]</message_id>  
  <status>ok</status>  
</xml>
```

Sample response:

```
<xml>  
  <message_id>297</message_id>  
  <status>ok</status>  
</xml>
```

Response (when wrong logindata):

```
<xml>  
  <error_text>Invalid login or password</error_text>  
  <status>error</status>  
</xml>
```

Response (when wrong access token):

```
<xml>  
  <error_text>Invalid Access token</error_text>  
  <status>error</status>  
</xml>
```

Response (when wrong parameters):

```
<xml>  
  <error_text>Wrong parameters</error_text>  
  <status>error</status>  
</xml>
```

Important notice: You must encode URL before sending it to gateway if you use national characters in SMS message text.

2. Send SMS/MMS: JSONRPC method

HTTP POST METHOD:

<https://url-of-smseagle/jsonrpc/sms>

PARAMETERS:

Parameter	Description
access_token	authentication access token (see details in point API Authentication)
login	your user to login to SMSEagle (see details in point API Authentication)
pass	your password to login to SMSEagle
to	recipient telephone number (or numbers separated with comma)
message	your SMS message
date	<i>(optional parameter)</i> date and time in format YYYYmmDDHHMM (YYYY – year, mm – month, DD – day, HH – hour, MM – minute). If this parameter is not null SMS will be scheduled for sending at the given date and time
highpriority	<i>(optional parameter)</i> 0 = normal priority, 1 = SMS will have higher priority in Outbox queue when processed by GSM-modem
unicode	<i>(optional parameter)</i> 0 = no Unicode encoding (default), 1 = SMS will be encoded using Unicode (you can send national characters)
flash	(optional parameter) 0 = normal SMS (default), 1 = SMS will be sent as flash message
oid	<i>(optional parameter)</i> This attribute specifies a user-defined unique ID that is assigned to a message-recipient pair. The oid is a varchar(36) that uniquely identifies a message sent to a particular recipient (particular phone number). The value of this ID allows client applications to match incoming reply messages to outgoing messages. If no oid was assigned to the outgoing message this attribute will have a value of null for incoming message. The oid value will be automatically assigned to incoming message only if incoming phone number matches exactly the phone number (including country code) from outgoing message.
modem_no	<i>(optional parameter)</i> sending modem number (only for multimodem devices)
responsetype	<i>(optional parameter)</i> simple = format response as simple object with one result field (default), extended = format response as extended JSON object
validity	<i>(optional parameter)</i> How long will be the message valid. If message expires before it is received by a phone, the message will be discarded by cellular network. Acceptable parameter values: 5m, 10m, 30m, 1h, 2h, 4h, 12h, 1d, 2d, 5d, 1w, 2w, 4w, max. Default value: max
send_after	<i>(optional parameter)</i> send a message after specified time. It can be used to prevent messages from being sent at night. Format: HH:MM:SS (HH – hour, MM – minute, SS – second)

send_before	<i>(optional parameter)</i> send a message before specified time. It can be used to prevent messages from being sent at night. Format: HH:MM:SS (HH – hour, MM – minute, SS – second)
message_type	<i>(optional parameter)</i> sms = normal SMS (default), mms = multimedia message MMS
attachments	<i>(optional parameter)</i> this parameter is only used when parameter message_type=mms The parameter accepts array with MMS attachments. Each array element must contain: <ul style="list-style-type: none"> • content-type: mime type of attached file. Supported mime-types: image/jpeg, image/gif, image/png, image/bmp • content: file content with data encoded in base64
test	<i>(optional parameter)</i> 1 = simulate message sending. Messages with that parameter will not be added to outbox and they will return ID = 0

SAMPLE BODY:

```
{ "method": "sms.send_sms",
  "params": { "access_token": "0005gOjCO1MH8F2x", "to": "481234567", "message": "My message" } }
or
{ "method": "sms.send_sms",
  "params": { "access_token": "0005gOjCO1MH8F2x", "to": "481234567", "message": "My message", "date": "201401152132" } }
or
{ "method": "sms.send_sms",
  "params": { "access_token": "0005gOjCO1MH8F2x", "to": "481234567", "message": "My message", "highpriority": "1" } }
```

SAMPLE BODY (MMS):

```
{ "method": "sms.send_sms",
  "params": { "access_token": "0005gOjCO1MH8F2x", "to": "481234567", "message": "My message", "message_type": "mms",
  "attachments": [ {
    "content_type": "image/png",
    "content": "/9j/4AAQSkZJRgABAQAAQABAAQ/2wBDAAE (...)",
  } ] } }
```

RESPONSE:

Response: {"result": "OK; ID=[ID of message in outbox]"}

Sample response: {"result": "OK; ID=297"}

Response (when wrong logindata): {"result": "Invalid login or password"}

Response (when wrong access token): {"result": "Invalid access token"}

Response (when wrong parameters): {"result": "Wrong parameters"}

RESPONSE (EXTENDED):

Response:

```
{ "result": { "message_id": "[ID of message in outbox]", "status": "ok" } }
```

Sample response: {"result": { "message_id": "748", "status": "ok" } }

Sample response when parameter "to" contains multiple phone numbers:

```
{ "result": [{"message_id": "3643", "status": "ok"}, {"message_id": "3644", "status": "ok"}, {"message_id": "3645", "status": "ok"}, {"message_id": "3646", "status": "ok"}, {"message_id": "3647", "status": "ok"}] }
```

Response (when wrong logindata):

```
{ "result": { "error_text": "Invalid login or password", "status": "error" } }
```

Response (when wrong access token):

```
{ "result": { "error_text": "Invalid access token", "status": "error" } }
```

Response (when wrong parameters):

```
{ "result": { "error_text": "Wrong parameters", "status": "error" } }
```

3. Send SMS to a group: HTTP GET method

HTTP GET METHOD:

https://url-of-smseagle/http_api/send_togroup

Parameter	Description
access_token	authentication access token (see details in point API Authentication)
login	your user to login to SMSEagle (see details in point API Authentication)
pass	your password to login to SMSEagle
groupname	group name defined in your SMSEagle Phonebook. The group must be defined as Public
message	your SMS message
date	<i>(optional parameter)</i> date and time in format YYYYmmDDHHMM (YYYY – year, mm – month, DD – day, HH – hour, MM – minute). If this parameter is not null SMS will be scheduled for sending at the given date and time
highpriority	<i>(optional parameter)</i> 0 = normal priority, 1 = SMS will have higher priority in Outbox queue when processed by GSM-modem
unicode	<i>(optional parameter)</i> 0 = no Unicode encoding (default), 1 = SMS will be encoded using Unicode (you can send national characters)
flash	<i>(optional parameter)</i> 0 = normal SMS (default), 1 = SMS will be sent as flash message
modem_no	<i>(optional parameter)</i> sending modem number (only for multimodem devices)
responsetype	<i>(optional parameter)</i> text = format response as text (default), xml = format response as XML object
validity	<i>(optional parameter)</i> How long will be the message valid. If message expires before it is received by a phone, the message will be discarded by cellular network. Acceptable parameter values: 5m, 10m, 30m, 1h, 2h, 4h, 12h, 1d, 2d, 5d, 1w, 2w, 4w, max. Default value: max
send_after	<i>(optional parameter)</i> send a message after specified time. It can be used to prevent messages from being sent at night. Format: HH:MM:SS (HH – hour, MM – minute, SS – second)

send_before	<i>(optional parameter)</i> send a message before specified time. It can be used to prevent messages from being sent at night. Format: HH:MM:SS (HH – hour, MM – minute, SS – second)
test	<i>(optional parameter)</i> 1 = simulate message sending. Messages with that parameter will not be added to outbox and they will return ID = 0

EXAMPLES:

`https://url-of-smseagle/http_api/send_togroup?`

`access_token=0005gOjCOlMH8F2x&groupname=admins&message=mymessage`

`https://url-of-smseagle/http_api/send_togroup?`

`access_token=0005gOjCOlMH8F2x&groupname=admins&message=mymessage&date=201401152132`

`https://url-of-smseagle/http_api/send_togroup?`

`access_token=0005gOjCOlMH8F2x&groupname=admins&message=mymessage&highpriority=1`

RESPONSE:

Response: **OK; ID=[ID of message in outbox]**

Sample response: OK; ID=297

Response (when wrong logindata): **Invalid login or password**

Response (when wrong access token): **Invalid access token**

Response (when wrong parameters): **Wrong parameters**

RESPONSE (XML):

Response:

```
<xml>
  <message_id>[ID of message in outbox]</message_id>
  <status>ok</status>
</xml>
```

Sample response:

```
<xml>
  <message_id>297</message_id>
  <status>ok</status>
</xml>
```

Response (when wrong logindata):

```
<xml>
  <error_text>Invalid login or password</error_text>
  <status>error</status>
</xml>
```

Response (when wrong access token):

```
<xml>
  <error_text>Invalid Access token</error_text>
  <status>error</status>
</xml>
```

Response (when wrong parameters):

```
<xml>
  <error_text>Wrong parameters</error_text>
  <status>error</status>
</xml>
```

4. Send SMS/MMS to a group: JSONRPC method

HTTP POST METHOD:

<https://url-of-smseagle/jsonrpc/sms>

Parameter	Description
access_token	authentication access token (see details in point API Authentication)
login	your user to login to SMSEagle (see details in point API Authentication)
pass	your password to login to SMSEagle
groupname	group name defined in your SMSEagle Phonebook. The group must be defined as Public
message	your SMS message
date	<i>(optional parameter)</i> date and time in format YYYYmmDDHHMM (YYYY – year, mm – month, DD – day, HH – hour, MM – minute). If this parameter is not null SMS will be scheduled for sending at the given date and time
highpriority	<i>(optional parameter)</i> 0 = normal priority, 1 = SMS will have higher priority in Outbox queue when processed by GSM-modem
unicode	<i>(optional parameter)</i> 0 = no Unicode encoding (default), 1 = SMS will be encoded using Unicode (you can send national characters)
flash	<i>(optional parameter)</i> 0 = normal SMS (default), 1 = SMS will be sent as flash message
modem_no	<i>(optional parameter)</i> sending modem number (only for multimodem devices)
responsetype	<i>(optional parameter)</i> simple = format response as simple object with one result field (default), extended = format response as extended JSON object
validity	<i>(optional parameter)</i> How long will be the message valid. If message expires before it is received by a phone, the message will be discarded by cellular network. Acceptable parameter values: 5m, 10m, 30m, 1h, 2h, 4h, 12h, 1d, 2d, 5d, 1w, 2w, 4w, max. Default value: max

send_after	<i>(optional parameter)</i> send a message after specified time. It can be used to prevent messages from being sent at night. Format: HH:MM:SS (HH – hour, MM – minute, SS – second)
send_before	<i>(optional parameter)</i> send a message before specified time. It can be used to prevent messages from being sent at night. Format: HH:MM:SS (HH – hour, MM – minute, SS – second)
message_type	<i>(optional parameter)</i> sms = normal SMS (default), mms = multimedia message MMS
attachments	<i>(optional parameter)</i> this parameter is only used when parameter message_type=mms The parameter accepts array with MMS attachments. Each array element must contain: <ul style="list-style-type: none"> • content-type: mime type of attached file. Supported mime-types: image/jpeg, image/gif, image/png, image/bmp • content: file content with data encoded in base64
test	<i>(optional parameter)</i> 1 = simulate message sending. Messages with that parameter will not be added to outbox and they will return ID = 0

EXAMPLES:

```
{ "method": "sms.send_togroup", "params": { "access_token":
"0005gOjCOlMH8F2x", "groupname": "admins", "message": "mymessage" } }
or
{ "method": "sms.send_togroup",
"params": { "access_token": "0005gOjCOlMH8F2x", "groupname": "admins", "message":
"mymessage", "date": "201401152132" } }
or
{ "method": "sms.send_togroup",
"params": { "access_token": "0005gOjCOlMH8F2x", "groupname": "admins", "message":
"mymessage", "highpriority": "1" } }
```

EXAMPLE (MMS):

```
{ "method": "sms.send_togroup",
"params": { "access_token": "0005gOjCOlMH8F2x", "groupname": "
admins", "message": "My message", "message_type": "mms",
"attachments": [ {
"content_type": "image/png",
"content": "/9j/4AAQSkZJRgABAQAAQABAAD/2wBDAAE (...)",
} ] }
```

RESPONSE:

Response: {"result": "OK; ID=[ID of message in outbox]"}

Sample response: {"result": "OK; ID=[297]"}

Response (when wrong logindata): {"result": "Invalid login or password"}

Response (when wrong access token): {"result": "Invalid access token"}

Response (when wrong parameters): {"result": "Wrong parameters"}

RESPONSE (EXTENDED):

Response:

```
{ "result": { "message_id": "[ID of message in outbox]", "status": "ok" } }
```

Sample response: {"result": {"message_id": "748", "status": "ok"}}

Response (when wrong logindata):

```
{"result": {"error_text": "Invalid login or password", "status": "error"}}
```

Response (when wrong access token):

```
{"result": {"error_text": "Invalid access token", "status": "error"}}
```

Response (when wrong parameters):

```
{"result": {"error_text": "Wrong parameters", "status": "error"}}
```

5. Send SMS to contact: HTTP GET method

HTTP GET METHOD:

https://url-of-smseagle/http_api/send_tocontact

Parameter	Description
access_token	authentication access token (see details in point API Authentication)
login	your user to login to SMSEagle (see details in point API Authentication)
pass	your password to login to SMSEagle
contactname	contact name (or names separated by comma) defined in your SMSEagle Phonebook. Contacts must be defined as Public
message	your SMS message
date	<i>(optional parameter)</i> date and time in format YYYYmmDDHHMM (YYYY – year, mm – month, DD – day, HH – hour, MM – minute). If this parameter is not null SMS will be scheduled for sending at the given date and time
highpriority	<i>(optional parameter)</i> 0 = normal priority, 1 = SMS will have higher priority in Outbox queue when processed by GSM-modem
unicode	<i>(optional parameter)</i> 0 = no Unicode encoding (default), 1 = SMS will be encoded using Unicode (you can send national characters)
flash	<i>(optional parameter)</i> 0 = normal SMS (default), 1 = SMS will be sent as flash message
modem_no	<i>(optional parameter)</i> sending modem number (only for multimodem devices)
responsetype	<i>(optional parameter)</i> text = format response as text (default), xml = format response as XML object
validity	<i>(optional parameter)</i> How long will be the message valid. If message expires before it is received by a phone, the message will be discarded by cellular network. Acceptable parameter values: 5m, 10m, 30m, 1h, 2h, 4h, 12h, 1d, 2d, 5d, 1w, 2w, 4w, max. Default value: max
send_after	<i>(optional parameter)</i> send a message after specified time. It can be used to prevent messages from being sent at night. Format: HH:MM:SS (HH – hour, MM – minute, SS – second)

send_before	<i>(optional parameter)</i> send a message before specified time. It can be used to prevent messages from being sent at night. Format: HH:MM:SS (HH – hour, MM – minute, SS – second)
test	<i>(optional parameter)</i> 1 = simulate message sending. Messages with that parameter will not be added to outbox and they will return ID = 0

EXAMPLES:

```
https://url-of-smseagle/http_api/send_tocontact?
access_token=0005gOjCOlMH8F2x&contactname=johndoe&message=mymessage

https://url-of-smseagle/http_api/send_tocontact?
access_token=0005gOjCOlMH8F2x&contactname=johndoe&message=mymessage&date=20
1401152132

https://url-of-smseagle/http_api/send_tocontact?
access_token=0005gOjCOlMH8F2x&contactname=johndoe&message=mymessage&highpri
ority=1
```

RESPONSE:

Response: **OK; ID=[ID of message in outbox]**

Sample response: OK; ID=297

Response (when wrong logindata): **Invalid login or password**

Response (when wrong access token): **Invalid access token**

Response (when contact doesn't exist): **Invalid contact name – [contact_name]**

Response (when wrong parameters): **Wrong parameters**

RESPONSE (XML):

Response:

```
<xml>
  <message_id>[ID of message in outbox]</message_id>
  <status>ok</status>
</xml>
```

Sample response:

```
<xml>
  <message_id>297</message_id>
  <status>ok</status>
</xml>
```

Response (when wrong logindata):

```
<xml>
  <error_text>Invalid login or password</error_text>
  <status>error</status>
```

```
</xml>
```

Response (when wrong access token):

```
<xml>  
  <error_text>Invalid Access token</error_text>  
  <status>error</status>  
</xml>
```

Response (when contact doesn't exist):

```
<xml>  
  <error_text>Invalid contact name – [contact_name]</error_text>  
  <status>error</status>  
</xml>
```

Response (when wrong parameters):

```
<xml>  
  <error_text>Wrong parameters</error_text>  
  <status>error</status>  
</xml>
```

6. Send SMS/MMS to contact: JSONRPC method

HTTP POST METHOD:

<https://url-of-smseagle/jsonrpc/sms>

Parameter	Description
access_token	authentication access token (see details in point API Authentication)
login	your user to login to SMSEagle (see details in point API Authentication)
pass	your password to login to SMSEagle
contactname	contact name defined in your SMSEagle Phonebook. The contact must be defined as Public
message	your SMS message
date	<i>(optional parameter)</i> date and time in format YYYYmmDDHHMM (YYYY – year, mm – month, DD – day, HH – hour, MM – minute). If this parameter is not null SMS will be scheduled for sending at the given date and time
highpriority	<i>(optional parameter)</i> 0 = normal priority, 1 = SMS will have higher priority in Outbox queue when processed by GSM-modem
unicode	<i>(optional parameter)</i> 0 = no Unicode encoding (default), 1 = SMS will be encoded using Unicode (you can send national characters)
flash	<i>(optional parameter)</i> 0 = normal SMS (default), 1 = SMS will be sent as flash message
modem_no	<i>(optional parameter)</i> sending modem number (only for multimodem devices)

responsetype	<i>(optional parameter)</i> simple = format response as simple object with one result field (default), extended = format response as extended JSON object
validity	<i>(optional parameter)</i> How long will be the message valid. If message expires before it is received by a phone, the message will be discarded by cellular network. Acceptable parameter values: 5m, 10m, 30m, 1h, 2h, 4h, 12h, 1d, 2d, 5d, 1w, 2w, 4w, max. Default value: max
send_after	<i>(optional parameter)</i> send a message after specified time. It can be used to prevent messages from being sent at night. Format: HH:MM:SS (HH – hour, MM – minute, SS – second)
send_before	<i>(optional parameter)</i> send a message before specified time. It can be used to prevent messages from being sent at night. Format: HH:MM:SS (HH – hour, MM – minute, SS – second)
message_type	<i>(optional parameter)</i> sms = normal SMS (default), mms = multimedia message MMS
attachments	<i>(optional parameter)</i> this parameter is only used when parameter message_type=mms The parameter accepts array with MMS attachments. Each array element must contain: <ul style="list-style-type: none"> • content-type: mime type of attached file. Supported mime-types: image/jpeg, image/gif, image/png, image/bmp • content: file content with data encoded in base64
test	<i>(optional parameter)</i> 1 = simulate message sending. Messages with that parameter will not be added to outbox and they will return ID = 0

EXAMPLES:

```

{"method":"sms.send_tocontact",
"params":{"access_token":"0005gOjCO1MH8F2x","contactname":"johndoe","message":"mymessage"}}
or
{"method":"sms.send_tocontact",
"params":{"access_token":"0005gOjCO1MH8F2x","contactname":"johndoe","message":"mymessage","date":"201401152132"}}
or
{"method":"sms.send_tocontact",
"params":{"access_token":"0005gOjCO1MH8F2x","contactname":"johndoe","message":"mymessage","highpriority":"1"}}

```

EXAMPLE (MMS):

```

{"method":"sms.send_togroup",
"params":{"access_token":"0005gOjCO1MH8F2x","contactname":"johndoe","message":"My message","message_type":"mms",
"attachments":[{"content_type":"image/png",
"content ":"/9j/4AAQSkZJRgABAQAAQABAAD/2wBDAAE (...)",
}]}}

```

RESPONSE:

Response: {"result": "OK; ID=[ID of message in outbox]"}

Sample response: {"result": "OK; ID=[297]"}

Response (when wrong logindata): {"result": "Invalid login or password"}

Response (when wrong access token): {"result": "Invalid access token"}

Response (when contact doesn't exist): {"result": "Invalid contact name - contact_name]"}

Response (when wrong parameters): {"result": "Wrong parameters"}

RESPONSE (EXTENDED):

Response:

```
{"result": {"message_id":"[ID of message in outbox]","status":"ok"}}
```

Sample response: {"result": {"message_id":"748","status":"ok"}}

Response (when wrong logindata):

```
{"result": {"error_text":"Invalid login or password","status":"error"}}
```

Response (when wrong access token):

```
{"result": {"error_text":"Invalid access token","status":"error"}}
```

Response (when contact doesn't exist):

```
{"result": {"error_text":"Invalid contact name - contact_name]","status":"error"}}
```

Response (when wrong parameters):

```
{"result": {"error_text":"Wrong parameters","status":"error"}}
```

7. Send USSD code: HTTP GET method

HTTP GET METHOD:

https://url-of-smseagle/http_api/send_ussd

Parameters:

Parameter	Description
access_token	authentication access token (see details in point API Authentication)
login	your user to login to SMSEagle (see details in point API Authentication)
pass	your password to login to SMSEagle
to	USSD code (urlencoded)
modem_no	<i>(optional parameter)</i> sending modem number (only for multimodem devices)
responsetype	<i>(optional parameter)</i> text = format response as text (default), xml = format response as XML object

EXAMPLES:

https://url-of-smseagle/http_api/send_ussd?

access_token=0005gOjCO1MH8F2x&to=%2A101%23

RESPONSE:

Response: **OK; ID=[ID of message in outbox]**

Sample response: OK; ID=297

Response (when wrong logindata): **Invalid login or password**

Response (when wrong access token): **Invalid access token**

Response (when wrong parameters): **Wrong parameters**

RESPONSE (XML):

Response:

```
<xml>
  <message_id>[ID of message in outbox]</message_id>
  <status>ok</status>
</xml>
```

Sample response:

```
<xml>
  <message_id>297</message_id>
  <status>ok</status>
</xml>
```

Response (when wrong logindata):

```
<xml>
  <error_text>Invalid login or password</error_text>
  <status>error</status>
</xml>
```

Response (when wrong access token):

```
<xml>
  <error_text>Invalid Access token</error_text>
  <status>error</status>
</xml>
```

Response (when wrong parameters):

```
<xml>
  <error_text>Wrong parameters</error_text>
  <status>error</status>
</xml>
```

Important notice: You must urlencode USSD code before sending it to gateway. Response from cellular network will show up in device Inbox folder.

8. Send USSD code: JSONRPC method

HTTP POST METHOD:

<https://url-of-smseagle/jsonrpc/sms>

Parameters:

Parameter	Description
access_token	authentication access token (see details in point API Authentication)
login	your user to login to SMSEagle (see details in point API Authentication)
pass	your password to login to SMSEagle
to	USSD code
modem_no	<i>(optional parameter)</i> sending modem number (only for multimodem devices)
responsetype	<i>(optional parameter)</i> text = format response as text (default), xml = format response as XML object

SAMPLE BODY:

```
{"method": "sms.send_ussd",  
"params": {"access_token": "0005gOjCOlMH8F2x", "to": "*101#"}}
```

RESPONSE:

Response: {"result": "OK; ID=[ID of message in outbox]"}

Sample response: {"result": "OK; ID=297"}

Response (when wrong logindata): {"result": "Invalid login or password"}

Response (when wrong access token): {"result": "Invalid access token"}

Response (when wrong parameters): {"result": "Wrong parameters"}

RESPONSE (EXTENDED):

Response:

```
{"result": {"message_id": "[ID of message in outbox]", "status": "ok"}}
```

Sample response: {"result": {"message_id": "748", "status": "ok"}}

Response (when wrong logindata):

```
{"result": {"error_text": "Invalid login or password", "status": "error"}}
```

Response (when wrong access token):

```
{"result": {"error_text": "Invalid access token", "status": "error"}}
```

Response (when wrong parameters):

```
{"result": {"error_text": "Wrong parameters", "status": "error"}}
```

Important notice: Response from cellular network will show up in device Inbox folder.

9. Send binary SMS: HTTP GET method

HTTP GET METHOD:

https://url-of-smseagle/http_api/send_binary_sms

PARAMETERS:

Parameter	Description
access_token	authentication access token (see details in point API Authentication)
login	your user to login to SMSEagle (see details in point API Authentication)
pass	your password to login to SMSEagle
to	recipient telephone number (or numbers separated with comma)
udh	<i>(optional parameter)</i> UDH header for the message (in hex format)
data	binary message (in hex format)
class	<i>(optional parameter)</i> message class
modem_no	<i>(optional parameter)</i> sending modem number (only for multimodem devices)
responsetype	<i>(optional parameter)</i> text = format response as text (default), xml = format response as XML object
test	<i>(optional parameter)</i> 1 = simulate message sending. Messages with that parameter will not be added to outbox and they will return ID = 0

EXAMPLES:

```
https://url-of-smseagle/http_api/send_binary_sms?
access_token=0005gOjCO1MH8F2x&to=1234567&udh=0605040B8423F0&data=EA0601AE02
056A0045C60C03777772E736D736561676C652E657500080103534D534561676C65000101
```

RESPONSE:

Response: **OK; ID=[ID of message in outbox]**

Sample response: OK; ID=297

Response (when wrong logindata): **Invalid login or password**

Response (when wrong access token): **Invalid access token**

Response (when wrong parameters): **Wrong or missing >>udh<< parameter**

Response (when wrong parameters): **Wrong or missing >>data<< parameter**

RESPONSE (XML):

Response:

```
<xml>
  <message_id>[ID of message in outbox]</message_id>
  <status>ok</status>
</xml>
```

Sample response:

```
<xml>
  <message_id>297</message_id>
  <status>ok</status>
</xml>
```

Response (when wrong logindata):

```
<xml>
  <error_text>Invalid login or password</error_text>
  <status>error</status>
</xml>
```

Response (when wrong access token):

```
<xml>
  <error_text>Invalid Access token</error_text>
  <status>error</status>
</xml>
```

Response (when wrong parameters):

```
<xml>
  <error_text> Wrong or missing >>udh<< parameter </error_text>
  <status>error</status>
</xml>
```

Response (when wrong parameters):

```
<xml>
  <error_text> Wrong or missing >>data<< parameter </error_text>
  <status>error</status>
</xml>
```

10. Send binary SMS: JSONRPC method

HTTP POST METHOD:

<https://url-of-smseagle/jsonrpc/sms>

PARAMETERS:

Parameter	Description
access_token	authentication access token (see details in point API Authentication)
login	your user to login to SMSEagle (see details in point API Authentication)
pass	your password to login to SMSEagle
to	recipient telephone number (or numbers separated with comma)
udh	<i>(optional parameter)</i> UDH header for the message (in hex format)
data	binary message (in hex format)
class	<i>(optional parameter)</i> message class

modem_no	<i>(optional parameter)</i> sending modem number (only for multimodem devices)
responsetype	<i>(optional parameter)</i> simple = format response as simple object with one result field (default), extended = format response as extended JSON object
test	<i>(optional parameter)</i> 1 = simulate message sending. Messages with that parameter will not be added to outbox and they will return ID = 0

EXAMPLES:

```
{ "method": "sms.send_binary_sms",
  "params": { "access_token": "0005gOjCO1MH8F2x", "to": "1234567", "udh": "0605040B8423F0", "data": "EA0601AE02056A0045C60C03777772E736D736561676C652E657500080103534D534561676C65000101" } }
```

RESPONSE:

Response: {"result": "OK; ID=[ID of message in outbox]"}

Sample response: {"result": "OK; ID=297"}

Response (when wrong logindata): {"result": "Invalid login or password"}

Response (when wrong access token): {"result": "Invalid access token"}

Response (when wrong parameters): {"result": "Wrong or missing >>udh<< parameter"}

Response (when wrong parameters): {"result": "Wrong or missing >>data<< parameter"}

RESPONSE (EXTENDED):

Response:

```
{ "result": { "message_id": "[ID of message in outbox]", "status": "ok" } }
```

Sample response: {"result": { "message_id": "748", "status": "ok" } }

Response (when wrong logindata):

```
{ "result": { "error_text": "Invalid login or password", "status": "error" } }
```

Response (when wrong access token):

```
{ "result": { "error_text": "Invalid access token", "status": "error" } }
```

Response (when wrong parameters):

```
{ "result": { "error_text": "Wrong or missing >>udh<< parameter",
  "status": "error" } }
```

Response (when wrong parameters):

```
{ "result": { "error_text": "Wrong or missing >>data<< parameter",
  "status": "error" } }
```

11. Read SMS: HTTP GET method

HTTP GET METHOD:

https://url-of-smseagle/http_api/read_sms

Parameter	Description
access_token	authentication access token (see details in point API Authentication)
login	your user to login to SMSEagle (see details in point API Authentication)
pass	your password to login to SMSEagle
folder	one of the following: inbox, outbox, sentitems
idfrom	<i>(optional parameter)</i> minimal message-id
idto	<i>(optional parameter)</i> maximum message-id
from	<i>(optional parameter)</i> telephone number of SMS sender (for inbox)
to	<i>(optional parameter)</i> telephone number of SMS receiver (for sentitems)
datefrom	<i>(optional parameter)</i> date and time in format YYYYmmDDHHMMSS (YYYY – year, mm – month, DD – day, HH – hour, MM – minutes, SS – seconds). Show only messages sent/received on this date/time and later
dateto	<i>(optional parameter)</i> date and time in format YYYYmmDDHHMMSS (YYYY – year, mm – month, DD – day, HH – hour, MM – minutes, SS – seconds). Show only messages sent/received on this date/time and earlier
limit	<i>(optional parameter)</i> how many messages to show
unread	<i>(optional parameter)</i> 1 = show only unread messages
responsetype	<i>(optional parameter)</i> text = format response as text (default), xml = format response as XML object
createdby	<i>(optional parameter)</i> username or email (if message was sent via Email to SMS) of sending user
modem_no	<i>(optional parameter)</i> sending modem number (only for multimodem devices)

EXAMPLES:

Show all messages from inbox:

```
https://url-of-smseagle/http_api/read_sms?
access_token=0005gOjCOlMH8F2x&folder=inbox
```

Show all unread messages from inbox:

```
https://url-of-smseagle/http_api/read_sms?
access_token=0005gOjCOlMH8F2x&folder=inbox&unread=1
```

Show messages from sentitems folder with id=1234 to 1236:

```
https://url-of-smseagle/http_api/read_sms?
access_token=0005gOjCOlMH8F2x&folder=sentitems&idfrom=1234&idto=1236
```

Show messages from inbox folder with sender phone number +481234567:

```
https://url-of-smseagle/http_api/read_sms?
access_token=0005gOjCOlMH8F2x&folder=inbox&from=+481234567
```

Show messages from sentitems folder with receiver phone number 7654321 and datetime from 2014-12-24 08:10:00 to 2014-12-31 23:59:59:

```
https://url-of-smseagle/http_api/read_sms?
```

access_token=0005gOjCOlMH8F2x&folder=sentitems&to=7654321&datefrom=20141224081000&dateto=20141231235959

RESPONSE:

Sample responses: [inbox folder](#), [sentitems folder](#)

Response (when no data): **No data to display**

Response (when wrong logindata): **Invalid login or password**

Response (when wrong access token): **Invalid access token**

Response (when wrong parameters): **Wrong parameters**

RESPONSE (XML):

Sample response (inbox folder):

```
<xml>
  <messages>
    <item>
      <UpdatedInDB>2018-07-17 15:11:31</UpdatedInDB>
      <ReceivingDateTime>2018-07-17 15:04:04</ReceivingDateTime>
      <Text>005400650073007400200031</Text>
      <SenderNumber>+48123456789</SenderNumber>
      <Coding>Default_No_Compression</Coding>
      <UDH></UDH>
      <SMSCNumber>+48790998250</SMSCNumber>
      <Class>-1</Class>
      <TextDecoded>Test 1</TextDecoded>
      <ID>124</ID>
      <RecipientID>smseagle1</RecipientID>
      <Processed>t</Processed>
      <id_folder>1</id_folder>
      <readed>>true</readed>
      <oid></oid>
      <Status>0</Status>
    </item>
    <item>
      <UpdatedInDB>2018-07-17 15:11:31</UpdatedInDB>
      <ReceivingDateTime>2018-07-17 15:04:10</ReceivingDateTime>
      <Text>005400650073007400200032</Text>
      <SenderNumber>+48123456788</SenderNumber>
      <Coding>Default_No_Compression</Coding>
      <UDH></UDH>
      <SMSCNumber>+48790998250</SMSCNumber>
      <Class>-1</Class>
      <TextDecoded>Test 2</TextDecoded>
      <ID>125</ID>
      <RecipientID>smseagle1</RecipientID>
      <Processed>t</Processed>
      <id_folder>1</id_folder>
      <readed>>true</readed>
      <oid>5208facc-5912-4d21-8d31-7f830cf8f24e</oid>
      <Status>0</Status>
    </item>
    <item>
      <UpdatedInDB>2018-07-17 15:11:31</UpdatedInDB>
      <ReceivingDateTime>2018-07-17 15:05:49</ReceivingDateTime>
      <Text>004C006F00720065006D00200069007000730075006D00200064006F006C006F00720
02000730069007400200061006D00650074002C00200063006F006E00730065006300740065
```

```

007400750072002000610064006900700069007300630069006E006700200065006C0069007
4002E002000430072006100730020006600650072006D0065006E00740075006D0020007500
6C006C0061006D0063006F007200700065007200200065006700650073007400610073002E0
020004E0075006C006C006100200070006C006100630065007200610074002000660069006E
006900620075007300200064006F006C006F0072002C0020006D0061006C006500730075006
10064006100200076006100720069007500730020006C006900670075006C00610020006800
65006E006400720065</Text>
    <SenderNumber>+48123456787</SenderNumber>
    <Coding>Default_No_Compression</Coding>
    <UDH>050003590301</UDH>
    <SMSCNumber>+48790998250</SMSCNumber>
    <Class>-1</Class>
    <TextDecoded>Lorem ipsum dolor sit amet, consectetur adipiscing
elit. Cras fermentum ullamcorper egestas. Nulla placerat finibus dolor,
malesuada varius ligula hendrerit sed. Nullam nisl sapien, molestie rhoncus
orci vel, viverra luctus ipsum. Praesent maximus luctus orci. Vestibulum
lacus dui, vestibulum ac aliquam eget, ultrices et mi. In ac felis urna.
Phasellus eget leo a leo congue ultricies. Donec tincidunt volutpat arcu a
commodo</TextDecoded>
    <ID>126</ID>
    <RecipientID>smseagle1</RecipientID>
    <Processed>t</Processed>
    <id_folder>1</id_folder>
    <readed>>true</readed>
    <oid></oid>
    <Status>0</Status>
  </item>
</messages>
<status>ok</status>
</xml>

```

Sample response (sentitems folder):

```

<xml>
  <messages>
    <item>
      <UpdatedInDB>2018-06-07 11:29:56</UpdatedInDB>
      <InsertIntoDB>2018-06-07 11:29:43</InsertIntoDB>
      <SendingDateTime>2018-06-07 11:29:56</SendingDateTime>
      <DeliveryDateTime>2018-06-07 11:30:05</DeliveryDateTime>
      <Text>0074006500730074</Text>
      <DestinationNumber>123456789</DestinationNumber>
      <Coding>Default_No_Compression</Coding>
      <UDH></UDH>
      <SMSCNumber>+48501200777</SMSCNumber>
      <Class>-1</Class>
      <TextDecoded>test</TextDecoded>
      <ID>456</ID>
      <SenderID>smseagle1</SenderID>
      <SequencePosition>1</SequencePosition>
      <Status>DeliveryOK</Status>
      <StatusError>-1</StatusError>
      <TPMR>116</TPMR>
      <RelativeValidity>255</RelativeValidity>
      <CreatorID>admin</CreatorID>
      <id_folder>3</id_folder>
      <StatusCode>-1</StatusCode>
    </item>
    <item>
      <UpdatedInDB>2018-07-13 11:40:45</UpdatedInDB>
      <InsertIntoDB>2018-07-13 11:40:40</InsertIntoDB>
      <SendingDateTime>2018-07-13 11:40:45</SendingDateTime>
      <DeliveryDateTime></DeliveryDateTime>

```

```

<Text></Text>
<DestinationNumber>*101#</DestinationNumber>
<Coding>8bit</Coding>
<UDH></UDH>
<SMSCNumber>+48501200777</SMSCNumber>
<Class>127</Class>
<TextDecoded></TextDecoded>
<ID>525</ID>
<SenderID>smseagle1</SenderID>
<SequencePosition>1</SequencePosition>
<Status>SendingOK</Status>
<StatusError>-1</StatusError>
<TPMR>-1</TPMR>
<RelativeValidity>255</RelativeValidity>
<CreatorID>admin</CreatorID>
<id_folder>3</id_folder>
<StatusCode>-1</StatusCode>
</item>
<item>
<UpdatedInDB>2018-07-18 14:25:41</UpdatedInDB>
<InsertIntoDB>2018-07-18 14:25:23</InsertIntoDB>
<SendingDateTime>2018-07-18 14:25:28</SendingDateTime>
<DeliveryDateTime>2018-07-18 14:25:28</DeliveryDateTime>
<Text>0054006500730074002000740065007300740031</Text>
<DestinationNumber>+48123456788</DestinationNumber>
<Coding>Default_No_Compression</Coding>
<UDH></UDH>
<SMSCNumber>+48601000310</SMSCNumber>
<Class>-1</Class>
<TextDecoded>Test test1</TextDecoded>
<ID>574</ID>
<SenderID>smseagle1</SenderID>
<SequencePosition>1</SequencePosition>
<Status>DeliveryOK</Status>
<StatusError>0</StatusError>
<TPMR>84</TPMR>
<RelativeValidity>255</RelativeValidity>
<CreatorID>admin</CreatorID>
<id_folder>3</id_folder>
<StatusCode>-1</StatusCode>
</item>
<item>
<UpdatedInDB>2018-07-18 14:27:13</UpdatedInDB>
<InsertIntoDB>2018-07-18 14:27:03</InsertIntoDB>
<SendingDateTime>2018-07-18 14:27:13</SendingDateTime>
<DeliveryDateTime></DeliveryDateTime>
<Text>00540065007300740020007700690074006800200075006E00690063006F006400650
0200065006E0063006F00640069006E0067003A00200105014200F30119017A0107</Text>
<DestinationNumber>123456788</DestinationNumber>
<Coding>Unicode_No_Compression</Coding>
<UDH></UDH>
<SMSCNumber>+48601000310</SMSCNumber>
<Class>-1</Class>
<TextDecoded>Test with unicode encoding: ałóęźć</TextDecoded>
<ID>576</ID>
<SenderID>smseagle2</SenderID>
<SequencePosition>1</SequencePosition>
<Status>SendingOK</Status>
<StatusError>-1</StatusError>
<TPMR>86</TPMR>
<RelativeValidity>255</RelativeValidity>
<CreatorID>admin</CreatorID>
<id_folder>3</id_folder>

```

```

        <StatusCode>-1</StatusCode>
    </item>
    <item>
        <UpdatedInDB>2018-07-18 14:27:36</UpdatedInDB>
        <InsertIntoDB>2018-07-18 14:27:32</InsertIntoDB>
        <SendingDateTime>2018-07-18 14:27:36</SendingDateTime>
        <DeliveryDateTime></DeliveryDateTime>

<Text>00540065007300740020006F006600200066006C0061007300680020006D006500730
073006100670065</Text>
        <DestinationNumber>123456788</DestinationNumber>
        <Coding>Default_No_Compression</Coding>
        <UDH></UDH>
        <SMSCNumber>+48601000310</SMSCNumber>
        <Class>0</Class>
        <TextDecoded>Test of flash message</TextDecoded>
        <ID>577</ID>
        <SenderID>smseagle2</SenderID>
        <SequencePosition>1</SequencePosition>
        <Status>SendingOK</Status>
        <StatusError>-1</StatusError>
        <TPMR>87</TPMR>
        <RelativeValidity>255</RelativeValidity>
        <CreatorID>admin</CreatorID>
        <id_folder>3</id_folder>
        <StatusCode>-1</StatusCode>
    </item>
    <item>
        <UpdatedInDB>2018-07-18 14:29:29</UpdatedInDB>
        <InsertIntoDB>2018-07-18 14:28:46</InsertIntoDB>
        <SendingDateTime>2018-07-18 14:29:29</SendingDateTime>
        <DeliveryDateTime></DeliveryDateTime>

<Text>0054006500730074002000770069007400680020006200610064002000700068006F0
06E00650020006E0075006D006200650072</Text>
        <DestinationNumber>11</DestinationNumber>
        <Coding>Default_No_Compression</Coding>
        <UDH></UDH>
        <SMSCNumber></SMSCNumber>
        <Class>-1</Class>
        <TextDecoded>Test with bad phone number</TextDecoded>
        <ID>578</ID>
        <SenderID>smseagle2</SenderID>
        <SequencePosition>1</SequencePosition>
        <Status>SendingError</Status>
        <StatusError>-1</StatusError>
        <TPMR>-1</TPMR>
        <RelativeValidity>255</RelativeValidity>
        <CreatorID>admin</CreatorID>
        <id_folder>3</id_folder>
        <StatusCode>21</StatusCode>
    </item>
</messages>
<status>ok</status>
</xml>

```

Response (when no data):

```

<xml>
  <error_text>No data to display</error_text>
  <status>error</status>
</xml>

```

Response (when wrong logindata):

```
<xml>
  <error_text>Invalid login or password</error_text>
  <status>error</status>
</xml>
```

Response (when wrong access token):

```
<xml>
  <error_text>Invalid Access token</error_text>
  <status>error</status>
</xml>
```

Response (when wrong parameters):

```
<xml>
  <error_text>Wrong parameters</error_text>
  <status>error</status>
</xml>
```

FIELD DESCRIPTION OF RESPONSE DATA – INBOX FOLDER:

Field	Data type	Description
UpdatedInDB	timestamp	when somebody (software, user) updated the message content or state
ReceivingDateTime	timestamp	when SMS was received
Text	text	SMS text encoded using hex values
SenderNumber	character varying (30)	SMS sender number
Coding	character varying (255)	SMS text coding. Possible values: 'Default_No_Compression', 'Unicode_No_Compression', '8bit', 'Default_Compression', 'Unicode_Compression'
UDH	text	User Data Header encoded using hex values
SMSCNumber	character varying (20)	SMSC number
Class	integer	SMS class (0 is flash SMS, -1 is normal SMS, 127 is USSD)
TextDecoded	text	decoded SMS text
ID	serial	SMS unique identification number
RecipientID	text	which modem received the message (for example: smseagle1, smseagle2)
Processed	boolean	whether SMS was processed by SMSEagle application
id_folder	integer	identification of storage folder. Possible values: 1 Inbox 5 Trash 11... Custom folder
readed	text	whether SMS was read in GUI or via API

oid	character varying (36)	user-defined unique ID that is assigned to a message-recipient pair. The oid uniquely identifies a message sent to a particular recipient (particular phone number). <i>More information: see send_sms method description</i>
Status	integer	Status of incoming message. Currently only used for USSD messages with following meaning: <ol style="list-style-type: none"> 1 Unknown status. 2 No action is needed, maybe network initiated USSD. 3 Reply is expected. 4 USSD dialog terminated. 5 Another client replied. 6 Operation not supported. 7 Network timeout.

FIELD DESCRIPTION OF RESPONSE DATA – SENTITEMS FOLDER:

Field	Data type	Description
UpdatedInDB	timestamp	when somebody (software, user) updated the message content or state
InsertIntoDB	timestamp	when message was inserted into database
SendingDateTime	timestamp	when message has been sent
DeliveryDateTime	timestamp	time of receiving a delivery report (if it has been enabled). Null if delivery report was not received.
Text	text	SMS text encoded using hex values
DestinationNumber	character varying (30)	destination number for SMS
Coding	character varying (255)	SMS text coding. Possible values: <i>'Default_No_Compression', 'Unicode_No_Compression', '8bit', 'Default_Compression', 'Unicode_Compression'</i>
UDH	text	User Data Header encoded using hex values
SMSCNumber	character varying (20)	number of SMSC, which sent SMS
Class	integer	SMS class (0 is flash SMS, -1 is normal SMS, 127 is USSD)
TextDecoded	text	decoded SMS text
ID	serial	SMS unique identification number
SenderID	character varying (255)	which modem sent the message <i>(for example: smseagle1, smseagle2)</i>
SequencePosition	integer	SMS number in SMS sequence
Status	character varying (255)	Status of message sending. Possible values: <i>SendingOK</i> <i>Message has been sent, waiting for delivery report</i> <i>SendingOKNoReport</i> <i>Message has been sent without asking for delivery report</i>

		<p><i>SendingError</i> <i>Sending has failed</i></p> <p><i>DeliveryOK</i> <i>Delivery report arrived and reported success</i></p> <p><i>DeliveryFailed</i> <i>Delivery report arrived and reports failure</i></p> <p><i>DeliveryPending</i> <i>Delivery report announced pending deliver</i></p> <p><i>DeliveryUnknown</i> <i>Delivery report reported unknown status</i></p> <p><i>Error</i> <i>Some other error happened during sending</i></p> <p><i>Notice: some cellular operators return "SendingOK" status instead of "DeliveryOK" for correctly delivered SMS. If you want to check for delivery status, please verify what you receive from your operator or instead use the field DeliveryDateTime.</i></p>
StatusError	integer	Status of delivery from delivery report message, codes are defined in GSM specification 03.40 section 9.2.3.15 (TP-Status)
TPMR	integer	The Message Reference field (TP-MR) as defined in GSM 03.40
RelativeValidity	integer	SMS relative validity (TP-VP) encoded as defined in GSM 03.40
CreatorID	text	username that created the SMS message
id_folder	integer	identification of storage folder. Possible values: 3 <i>Sent items</i> 5 <i>Trash</i> 11... <i>Custom folder</i>
StatusCode	integer	CMS status code (also known as CMS ERROR) received from cellular network. - 1 <i>No CMS Error</i> > -1 <i>CMS Error occurred. CMS error number is saved in this field.</i>

12. Read SMS/MMS: JSONRPC method

HTTP POST METHOD:

<https://url-of-smseagle/jsonrpc/sms>

Parameter	Description
access_token	authentication access token (see details in point API Authentication)
login	your user to login to SMSEagle (see details in point API Authentication)
pass	your password to login to SMSEagle
folder	one of the following: inbox, outbox, sentitems

idfrom	<i>(optional parameter)</i> minimal message-id
idto	<i>(optional parameter)</i> maximum message-id
from	<i>(optional parameter)</i> telephone number of SMS sender (for inbox)
to	<i>(optional parameter)</i> telephone number of SMS receiver (for sentitems)
datefrom	<i>(optional parameter)</i> date and time in format YYYYmmDDHHMMSS (YYYY – year, mm – month, DD – day, HH – hour, MM – minutes, SS – seconds). Show only messages sent/received on this date/time and later
dateto	<i>(optional parameter)</i> date and time in format YYYYmmDDHHMMSS (YYYY – year, mm – month, DD – day, HH – hour, MM – minutes, SS – seconds). Show only messages sent/received on this date/time and earlier
limit	<i>(optional parameter)</i> how many messages to show
unread	<i>(optional parameter)</i> 1 = show only unread messages
responsetype	<i>(optional parameter)</i> simple = format response as simple object with one result field (default), extended = format response as extended JSON object
createdby	<i>(optional parameter)</i> username or email (if message was sent via Email to SMS) of sending user
modem_no	<i>(optional parameter)</i> sending modem number (only for multimodem devices)
Include_attachments	<i>(optional parameter)</i> add attachments for MMS messages

EXAMPLES:

Show all messages from inbox:

```
{ "method": "sms.read_sms",
  "params": { "access_token": "0005gOjCO1MH8F2x", "folder": "inbox" } }
```

Show all unread messages from inbox:

```
{ "method": "sms.read_sms",
  "params": { "access_token": "0005gOjCO1MH8F2x", "folder": "inbox", "unread": "1" } }
```

Show messages from sentitems folder with id=1234 to 1236:

```
{ "method": "sms.read_sms",
  "params": { "access_token": "0005gOjCO1MH8F2x", "folder": "sentitems", "idfrom": "1234", "idto": "1236" } }
```

Show messages from inbox folder with sender phone number +481234567:

```
{ "method": "sms.read_sms",
  "params": { "access_token": "0005gOjCO1MH8F2x", "folder": "inbox", "from": "481234567" } }
```

Show messages from sentitems folder with receiver phone number 7654321 and datetime from 2014-12-24 08:10:00 to 2014-12-31 23:59:59:

```
{ "method": "sms.read_sms", "params": { "access_token": "0005gOjCO1MH8F2x", "folder": "sentitems", "to": "7654321", "datefrom": "20141224081000", "dateto": "20141231235959" } }
```

RESPONSE:

Sample response (inbox folder):

```
{
  "result": [
    {
      "UpdatedInDB": "2018-07-18 13:56:16",
      "ReceivingDateTime": "2018-07-17 15:04:04",
      "Text": "005400650073007400200031",
      "SenderNumber": "+48123456789",
      "Coding": "Default_No_Compression",
      "UDH": "",
      "SMSCNumber": "+48790998250",
      "Class": "-1",
      "TextDecoded": "Test 1",
      "ID": "124",
      "RecipientID": "smseagle1",
      "Processed": "t",
      "id_folder": "1",
      "readed": "true",
      "oid": "",
      "Status": "0"
    },
    {
      "UpdatedInDB": "2018-07-18 13:56:16",
      "ReceivingDateTime": "2018-07-17 15:04:10",
      "Text": "005400650073007400200032",
      "SenderNumber": "+48123456788",
      "Coding": "Default_No_Compression",
      "UDH": "",
      "SMSCNumber": "+48790998250",
      "Class": "-1",
      "TextDecoded": "Test 2",
      "ID": "125",
      "RecipientID": "smseagle1",
      "Processed": "t",
      "id_folder": "1",
      "readed": "true",
      "oid": "5208facc-5912-4d21-8d31-7f830cf8f24e",
      "Status": "0"
    },
    {
      "UpdatedInDB": "2018-07-18 13:56:16",
      "ReceivingDateTime": "2018-07-17 15:05:49",
      "Text":
"004C006F00720065006D00200069007000730075006D00200064006F006C006F0072002000
730069007400200061006D00650074002C00200063006F006E0073006500630074006500740
0750072002000610064006900700069007300630069006E006700200065006C00690074002E
002000430072006100730020006600650072006D0065006E00740075006D00200075006C006
C0061006D0063006F007200700065007200200065006700650073007400610073002E002000
4E0075006C006C006100200070006C006100630065007200610074002000660069006E00690
0620075007300200064006F006C006F0072002C0020006D0061006C00650073007500610064
006100200076006100720069007500730020006C006900670075006C0061002000680065006
E006400720065",
      "SenderNumber": "+48123456787",
      "Coding": "Default_No_Compression",
      "UDH": "050003590301",
      "SMSCNumber": "+48790998250",
      "Class": "-1",
      "TextDecoded": "Lorem ipsum dolor sit amet, consectetur
adipiscing elit. Cras fermentum ullamcorper egestas. Nulla placerat finibus
dolor, malesuada varius ligula hendrerit sed. Nullam nisl sapien, molestie
rhoncus orci vel, viverra luctus ipsum. Praesent maximus luctus orci.
Vestibulum lacus dui, vestibulum ac aliquam eget, ultrices et mi. In ac
```

```

felis urna. Phasellus eget leo a leo congue ultricies. Donec tincidunt
volutpat arcu a commodo",
  "ID": "126",
  "RecipientID": "smseagle1",
  "Processed": "t",
  "id_folder": "1",
  "readed": "true",
  "oid": "",
  "Status": "0"
}
]
}

```

Sample response (sentitems folder):

```

{
  "result": [
    {
      "UpdatedInDB": "2018-06-07 11:29:56",
      "InsertIntoDB": "2018-06-07 11:29:43",
      "SendingDateTime": "2018-06-07 11:29:56",
      "DeliveryDateTime": "2018-06-07 11:30:05",
      "Text": "0074006500730074",
      "DestinationNumber": "+48123456789",
      "Coding": "Default_No_Compression",
      "UDH": "",
      "SMSCNumber": "+48501200777",
      "Class": "-1",
      "TextDecoded": "test",
      "ID": "456",
      "SenderID": "smseagle1",
      "SequencePosition": "1",
      "Status": "DeliveryOK",
      "StatusError": "-1",
      "TPMR": "116",
      "RelativeValidity": "255",
      "CreatorID": "admin",
      "id_folder": "3",
      "StatusCode": "-1"
    },
    {
      "UpdatedInDB": "2018-07-13 11:40:45",
      "InsertIntoDB": "2018-07-13 11:40:40",
      "SendingDateTime": "2018-07-13 11:40:45",
      "DeliveryDateTime": null,
      "Text": "",
      "DestinationNumber": "*101#",
      "Coding": "8bit",
      "UDH": "",
      "SMSCNumber": "+48501200777",
      "Class": "127",
      "TextDecoded": "",
      "ID": "525",
      "SenderID": "smseagle1",
      "SequencePosition": "1",
      "Status": "SendingOK",
      "StatusError": "-1",
      "TPMR": "-1",
      "RelativeValidity": "255",
      "CreatorID": "admin",
      "id_folder": "3",
      "StatusCode": "-1"
    },
    {

```

```

    "UpdatedInDB": "2018-07-18 14:25:41",
    "InsertIntoDB": "2018-07-18 14:25:23",
    "SendingDateTime": "2018-07-18 14:25:28",
    "DeliveryDateTime": "2018-07-18 14:25:28",
    "Text": "0054006500730074002000740065007300740031",
    "DestinationNumber": "+48123456788",
    "Coding": "Default_No_Compression",
    "UDH": "",
    "SMSCNumber": "+48601000310",
    "Class": "-1",
    "TextDecoded": "Test test1",
    "ID": "574",
    "SenderID": "smseagle1",
    "SequencePosition": "1",
    "Status": "DeliveryOK",
    "StatusError": "0",
    "TPMR": "84",
    "RelativeValidity": "255",
    "CreatorID": "admin",
    "id_folder": "3",
    "StatusCode": "-1"
  },
  {
    "UpdatedInDB": "2018-07-18 14:27:13",
    "InsertIntoDB": "2018-07-18 14:27:03",
    "SendingDateTime": "2018-07-18 14:27:13",
    "DeliveryDateTime": null,
    "Text":
"00540065007300740020007700690074006800200075006E00690063006F00640065002000
65006E0063006F00640069006E0067003A00200105014200F30119017A0107",
    "DestinationNumber": "123456788",
    "Coding": "Unicode_No_Compression",
    "UDH": "",
    "SMSCNumber": "+48601000310",
    "Class": "-1",
    "TextDecoded": "Test with unicode encoding: ałóęźć",
    "ID": "576",
    "SenderID": "smseagle1",
    "SequencePosition": "1",
    "Status": "SendingOK",
    "StatusError": "-1",
    "TPMR": "86",
    "RelativeValidity": "255",
    "CreatorID": "admin",
    "id_folder": "3",
    "StatusCode": "-1"
  },
  {
    "UpdatedInDB": "2018-07-18 14:27:36",
    "InsertIntoDB": "2018-07-18 14:27:32",
    "SendingDateTime": "2018-07-18 14:27:36",
    "DeliveryDateTime": null,
    "Text":
"00540065007300740020006F006600200066006C0061007300680020006D00650073007300
6100670065",
    "DestinationNumber": "123456788",
    "Coding": "Default_No_Compression",
    "UDH": "",
    "SMSCNumber": "+48601000310",
    "Class": "0",
    "TextDecoded": "Test of flash message",
    "ID": "577",
    "SenderID": "smseagle1",
    "SequencePosition": "1",

```

```

        "Status": "SendingOK",
        "StatusError": "-1",
        "TPMR": "87",
        "RelativeValidity": "255",
        "CreatorID": "admin",
        "id_folder": "3",
        "StatusCode": "-1"
    },
    {
        "UpdatedInDB": "2018-07-18 14:29:29",
        "InsertIntoDB": "2018-07-18 14:28:46",
        "SendingDateTime": "2018-07-18 14:29:29",
        "DeliveryDateTime": null,
        "Text":
"0054006500730074002000770069007400680020006200610064002000700068006F006E00
650020006E0075006D006200650072",
        "DestinationNumber": "11",
        "Coding": "Default_No_Compression",
        "UDH": "",
        "SMSCNumber": "",
        "Class": "-1",
        "TextDecoded": "Test with bad phone number",
        "ID": "578",
        "SenderID": "smseagle1",
        "SequencePosition": "1",
        "Status": "SendingError",
        "StatusError": "-1",
        "TPMR": "-1",
        "RelativeValidity": "255",
        "CreatorID": "admin",
        "id_folder": "3",
        "StatusCode": "21"
    }
]
}

```

Sample response (with include_attachments parameter):

```

{
  "result": [
    {
      "UpdatedInDB": "2020-12-18 16:52:32",
      "InsertIntoDB": "2020-12-18 16:52:16",
      "SendingDateTime": "2020-12-18 16:52:32",
      "DeliveryDateTime": null,
      "Text": "0054006500730074002000740065007300740031",
      "DestinationNumber": "+48601000310",
      "Coding": "Unicode_No_Compression",
      "UDH": "",
      "SMSCNumber": "",
      "Class": "100",
      "TextDecoded": "Test test1",
      "ID": "1174",
      "SenderID": "smseagle1",
      "SequencePosition": "1",
      "Status": "SendingOKNoReport",
      "StatusError": "-1",
      "TPMR": "-1",
      "RelativeValidity": "255",
      "CreatorID": "admin",
      "id_folder": "3",
    }
  ]
}

```

```

    "StatusCode": "200",
    "MMS_ID": "F9188B35A22EB175",
    "MMSHeaders": "",
    "MMSReports": null,
    "Attachments": [
      {
        "ContentType": "image/jpeg",
        "Content": "Lz1qLzRBQVFTalpKUmd (...)"
      },
      {
        "ContentType": "image/gif",
        "Content": "UjBsR09EbGhaQUE0QVB"
      }
    ]
  }
]
}

```

Response (when no data): {"result": "No data to display"}

Response (when wrong logindata): {"result": "Invalid login or password"}

Response (when wrong access token): {"result": "Invalid access token"}

Response (when wrong parameters): {"result": "Wrong parameters"}

RESPONSE (EXTENDED):

Sample response (inbox folder):

```

{
  "result": {
    "messages": [
      {
        "UpdatedInDB": "2018-07-18 14:06:06",
        "ReceivingDateTime": "2018-07-17 15:04:04",
        "Text": "005400650073007400200031",
        "SenderNumber": "+48123456789",
        "Coding": "Default_No_Compression",
        "UDH": "",
        "SMSCNumber": "+48790998250",
        "Class": "-1",
        "TextDecoded": "Test 1",
        "ID": "124",
        "RecipientID": "smseagle1",
        "Processed": "t",
        "id_folder": "1",
        "readed": "true",
        "oid": "",
        "Status": "0"
      },
      {
        "UpdatedInDB": "2018-07-18 14:06:06",
        "ReceivingDateTime": "2018-07-17 15:04:10",
        "Text": "005400650073007400200032",
        "SenderNumber": "+48123456788",
        "Coding": "Default_No_Compression",
        "UDH": "",
        "SMSCNumber": "+48790998250",
        "Class": "-1",
        "TextDecoded": "Test 2",
      }
    ]
  }
}

```

```

        "ID": "125",
        "RecipientID": "smseagle1",
        "Processed": "t",
        "id_folder": "1",
        "readed": "true",
        "oid": "5208facc-5912-4d21-8d31-7f830cf8f24e",
        "Status": "0"
    },
    {
        "UpdatedInDB": "2018-07-18 14:06:06",
        "ReceivingDateTime": "2018-07-17 15:05:49",
        "Text":
"004C006F00720065006D00200069007000730075006D00200064006F006C006F0072002000
730069007400200061006D00650074002C00200063006F006E0073006500630074006500740
0750072002000610064006900700069007300630069006E006700200065006C00690074002E
002000430072006100730020006600650072006D0065006E00740075006D00200075006C006
C0061006D0063006F007200700065007200200065006700650073007400610073002E002000
4E0075006C006C006100200070006C006100630065007200610074002000660069006E00690
0620075007300200064006F006C006F0072002C0020006D0061006C00650073007500610064
006100200076006100720069007500730020006C006900670075006C0061002000680065006
E006400720065",
        "SenderNumber": "+48123456787",
        "Coding": "Default_No_Compression",
        "UDH": "050003590301",
        "SMSCNumber": "+48790998250",
        "Class": "-1",
        "TextDecoded": "Lorem ipsum dolor sit amet, consectetur
adipiscing elit. Cras fermentum ullamcorper egestas. Nulla placerat finibus
dolor, malesuada varius ligula hendrerit sed. Nullam nisl sapien, molestie
rhoncus orci vel, viverra luctus ipsum. Praesent maximus luctus orci.
Vestibulum lacus dui, vestibulum ac aliquam eget, ultrices et mi. In ac
felis urna. Phasellus eget leo a leo congue ultricies. Donec tincidunt
volutpat arcu a commodo",
        "ID": "126",
        "RecipientID": "smseagle1",
        "Processed": "t",
        "id_folder": "1",
        "readed": "true",
        "oid": "",
        "Status": "0"
    }
],
"status": "ok"
}
}

```

Sample response (sentitems folder):

```

{
  "result": {
    "messages": [
      {
        "UpdatedInDB": "2018-06-07 11:29:56",
        "InsertIntoDB": "2018-06-07 11:29:43",
        "SendingDateTime": "2018-06-07 11:29:56",
        "DeliveryDateTime": "2018-06-07 11:30:05",
        "Text": "0074006500730074",
        "DestinationNumber": "+48123456789",
        "Coding": "Default_No_Compression",
        "UDH": "",
        "SMSCNumber": "+48501200777",
        "Class": "-1",
        "TextDecoded": "test",

```



```

    "ID": "456",
    "SenderID": "smseagle1",
    "SequencePosition": "1",
    "Status": "DeliveryOK",
    "StatusError": "-1",
    "TPMR": "116",
    "RelativeValidity": "255",
    "CreatorID": "admin",
    "id_folder": "3",
    "StatusCode": "-1"
  },
  {
    "UpdatedInDB": "2018-07-13 11:40:45",
    "InsertIntoDB": "2018-07-13 11:40:40",
    "SendingDateTime": "2018-07-13 11:40:45",
    "DeliveryDateTime": null,
    "Text": "",
    "DestinationNumber": "*101#",
    "Coding": "8bit",
    "UDH": "",
    "SMSCNumber": "+48501200777",
    "Class": "127",
    "TextDecoded": "",
    "ID": "525",
    "SenderID": "smseagle1",
    "SequencePosition": "1",
    "Status": "SendingOK",
    "StatusError": "-1",
    "TPMR": "-1",
    "RelativeValidity": "255",
    "CreatorID": "admin",
    "id_folder": "3",
    "StatusCode": "-1"
  },
  {
    "UpdatedInDB": "2018-07-18 14:25:41",
    "InsertIntoDB": "2018-07-18 14:25:23",
    "SendingDateTime": "2018-07-18 14:25:28",
    "DeliveryDateTime": "2018-07-18 14:25:28",
    "Text": "0054006500730074002000740065007300740031",
    "DestinationNumber": "+48123456788",
    "Coding": "Default_No_Compression",
    "UDH": "",
    "SMSCNumber": "+48601000310",
    "Class": "-1",
    "TextDecoded": "Test test1",
    "ID": "574",
    "SenderID": "smseagle1",
    "SequencePosition": "1",
    "Status": "DeliveryOK",
    "StatusError": "0",
    "TPMR": "84",
    "RelativeValidity": "255",
    "CreatorID": "admin",
    "id_folder": "3",
    "StatusCode": "-1"
  },
  {
    "UpdatedInDB": "2018-07-18 14:27:13",
    "InsertIntoDB": "2018-07-18 14:27:03",
    "SendingDateTime": "2018-07-18 14:27:13",
    "DeliveryDateTime": null,

```

```

        "Text":
"00540065007300740020007700690074006800200075006E00690063006F00640065002000
65006E0063006F00640069006E0067003A00200105014200F30119017A0107",
        "DestinationNumber": "123456788",
        "Coding": "Unicode_No_Compression",
        "UDH": "",
        "SMSCNumber": "+48601000310",
        "Class": "-1",
        "TextDecoded": "Test with unicode encoding: ąłóęźć",
        "ID": "576",
        "SenderID": "smseagle1",
        "SequencePosition": "1",
        "Status": "SendingOK",
        "StatusError": "-1",
        "TPMR": "86",
        "RelativeValidity": "255",
        "CreatorID": "admin",
        "id_folder": "3",
        "StatusCode": "-1"
    },
    {
        "UpdatedInDB": "2018-07-18 14:27:36",
        "InsertIntoDB": "2018-07-18 14:27:32",
        "SendingDateTime": "2018-07-18 14:27:36",
        "DeliveryDateTime": null,
        "Text":
"00540065007300740020006F006600200066006C0061007300680020006D00650073007300
6100670065",
        "DestinationNumber": "123456788",
        "Coding": "Default_No_Compression",
        "UDH": "",
        "SMSCNumber": "+48601000310",
        "Class": "0",
        "TextDecoded": "Test of flash message",
        "ID": "577",
        "SenderID": "smseagle1",
        "SequencePosition": "1",
        "Status": "SendingOK",
        "StatusError": "-1",
        "TPMR": "87",
        "RelativeValidity": "255",
        "CreatorID": "admin",
        "id_folder": "3",
        "StatusCode": "-1"
    },
    {
        "UpdatedInDB": "2018-07-18 14:29:29",
        "InsertIntoDB": "2018-07-18 14:28:46",
        "SendingDateTime": "2018-07-18 14:29:29",
        "DeliveryDateTime": null,
        "Text":
"0054006500730074002000770069007400680020006200610064002000700068006F006E00
650020006E0075006D006200650072",
        "DestinationNumber": "11",
        "Coding": "Default_No_Compression",
        "UDH": "",
        "SMSCNumber": "",
        "Class": "-1",
        "TextDecoded": "Test with bad phone number",
        "ID": "578",
        "SenderID": "smseagle1",
        "SequencePosition": "1",
        "Status": "SendingError",
        "StatusError": "-1",

```

```

        "TPMR": "-1",
        "RelativeValidity": "255",
        "CreatorID": "admin",
        "id_folder": "3",
        "StatusCode": "21"
    }
],
"status": "ok"
}

```

Sample response (with include_attachments parameter):

```

{
  "result": {
    "messages": [
      {
        "UpdatedInDB": "2020-12-18 16:52:32",
        "InsertIntoDB": "2020-12-18 16:52:16",
        "SendingDateTime": "2020-12-18 16:52:32",
        "DeliveryDateTime": null,
        "Text": "0054006500730074002000740065007300740031",
        "DestinationNumber": "+48601000310",
        "Coding": "Unicode_No_Compression",
        "UDH": "",
        "SMSCNumber": "",
        "Class": "100",
        "TextDecoded": "Test test1",
        "ID": "1174",
        "SenderID": "smseagle1",
        "SequencePosition": "1",
        "Status": "SendingOKNoReport",
        "StatusError": "-1",
        "TPMR": "-1",
        "RelativeValidity": "255",
        "CreatorID": "admin",
        "id_folder": "3",
        "StatusCode": "200",
        "MMS_ID": "F9188B35A22EB175",
        "MMSHeaders": "",
        "MMSReports": null,
        "Attachments": [
          {
            "ContentType": "image/jpeg",
            "Content": "Lz1qLzRBQVFTalp"
          },
          {
            "ContentType": "image/gif",
            "Content": "UjBsR09EbGhaQUE"
          }
        ]
      }
    ]
  },
  "status": "ok"
}

```

Response (when no data):

```

{"result": {"error_text": " No data to display ", "status": "error"}}

```

Response (when wrong logindata):

```

{"result": {"error_text": "Invalid login or password", "status": "error"}}

```

Response (when wrong access token):

```
{"result": {"error_text": "Invalid access token", "status": "error"}}
```

Response (when wrong parameters):

```
{"result": {"error_text": " Wrong or missing >>udh<< parameter", "status": "error"}}
```

FIELD DESCRIPTION OF RESPONSE DATA – INBOX FOLDER:

Field	Data type	Description
UpdatedInDB	timestamp	when somebody (software, user) updated the message content or state
ReceivingDateTime	timestamp	when SMS was received
Text	text	SMS text encoded using hex values
SenderNumber	character varying (30)	SMS sender number
Coding	character varying (255)	SMS text coding. Possible values: <i>'Default_No_Compression', 'Unicode_No_Compression', '8bit', 'Default_Compression', 'Unicode_Compression'</i>
UDH	text	User Data Header encoded using hex values
SMSCNumber	character varying (20)	SMSC number
Class	integer	SMS class (0 is flash SMS, -1 is normal SMS, 127 is USSD)
TextDecoded	text	decoded SMS text
ID	serial	SMS unique identification number
RecipientID	text	which modem received the message <i>(for example: smseagle1, smseagle2)</i>
Processed	boolean	whether SMS was processed by SMSEagle application
id_folder	integer	identification of storage folder. Possible values: <i>1 Inbox</i> <i>5 Trash</i> <i>11... Custom folder</i>
readed	text	whether SMS was read in GUI or via API
oid	character varying (36)	user-defined unique ID that is assigned to a message-recipient pair. The oid uniquely identifies a message sent to a particular recipient (particular phone number). <i>More information: see send_sms method description</i>
Status	integer	Status of incoming message. Currently only used for USSD messages with following meaning: <i>1 Unknown status.</i> <i>2 No action is needed, maybe network initiated USSD.</i> <i>3 Reply is expected.</i> <i>4 USSD dialog terminated.</i> <i>5 Another client replied.</i> <i>6 Operation not supported.</i>

		7 Network timeout.
MMS_ID	text	Field available when include_attachments parameter has been set to 1. Contains ID of MMS message that was set by MMSC.
MMSHeaders	text	Field available when include_attachments parameter has been set to 1. Contains headers from MMS message.
MMSReports	text	Field available when include_attachments parameter has been set to 1. Contains delivery report from MMSC for sent MMS messages.
Attachments	array text	Field available when include_attachments parameter has been set to 1. Contains media attachments for MMS messages. Array contains the following fields: <ul style="list-style-type: none"> • ContentType – MIME type of the attached file • Content – base64 encoded content of the attached file

FIELD DESCRIPTION OF RESPONSE DATA – SENTITEMS FOLDER:

Field	Data type	Description
UpdatedInDB	timestamp	when somebody (software, user) updated the message content or state
InsertIntoDB	timestamp	when message was inserted into database
SendingDateTime	timestamp	when message has been sent
DeliveryDateTime	timestamp	time of receiving a delivery report (if it has been enabled). Null if delivery report was not received.
Text	text	SMS text encoded using hex values
DestinationNumber	character varying (30)	destination number for SMS
Coding	character varying (255)	SMS text coding. Possible values: 'Default_No_Compression', 'Unicode_No_Compression', '8bit', 'Default_Compression', 'Unicode_Compression'
UDH	text	User Data Header encoded using hex values
SMSCNumber	character varying (20)	number of SMSC, which sent SMS
Class	integer	SMS class (0 is flash SMS, -1 is normal SMS, 127 is USSD)
TextDecoded	text	decoded SMS text
ID	serial	SMS unique identification number
SenderID	character varying (255)	which modem sent the message (for example: smseagle1, smseagle2)
SequencePosition	integer	SMS number in SMS sequence
Status	character varying (255)	Status of message sending. Possible values: SendingOK Message has been sent, waiting for delivery report SendingOKNoReport

		<p><i>Message has been sent without asking for delivery report</i></p> <p><i>SendingError</i></p> <p><i>Sending has failed</i></p> <p><i>DeliveryOK</i></p> <p><i>Delivery report arrived and reported success</i></p> <p><i>DeliveryFailed</i></p> <p><i>Delivery report arrived and reports failure</i></p> <p><i>DeliveryPending</i></p> <p><i>Delivery report announced pending deliver</i></p> <p><i>DeliveryUnknown</i></p> <p><i>Delivery report reported unknown status</i></p> <p><i>Error</i></p> <p><i>Some other error happened during sending</i></p> <p><i>Notice: some cellular operators return "SendingOK" status instead of "DeliveryOK" for correctly delivered SMS. If you want to check for delivery status, please verify what values you receive from your operator or instead use the field DeliveryDateTime.</i></p>
StatusError	integer	Status of delivery from delivery report message, codes are defined in GSM specification 03.40 section 9.2.3.15 (TP-Status)
TPMR	integer	The Message Reference field (TP-MR) as defined in GSM 03.40
RelativeValidity	integer	SMS relative validity (TP-VP) encoded as defined in GSM 03.40
CreatorID	text	username that created the SMS message
id_folder	integer	identification of storage folder. Possible values: 3 Sent items 5 Trash 11... Custom folder
StatusCode	integer	CMS status code (also known as CMS ERROR) received from cellular network. - 1 No CMS Error > -1 CMS Error occurred. CMS error number is saved in this field.
MMS_ID	text	Field available when include_attachments parameter has been set to 1. Contains ID of MMS message that was set by MMSC.
MMSHeaders	text	Field available when include_attachments parameter has been set to 1. Contains headers from MMS message.
MMSReports	text	Field available when include_attachments parameter has been set to 1. Contains delivery report from MMSC for sent MMS messages.

Attachments	array text	Field available when include_attachments parameter has been set to 1. Contains media attachments for MMS messages. Array contains the following fields: <ul style="list-style-type: none"> ContentType – MIME type of the attached file Content – base64 encoded content of the attached file
-------------	------------	---

13. Delete SMS: HTTP GET method

HTTP GET METHOD:

https://url-of-smseagle/http_api/delete_sms

Parameter	Description
access_token	authentication access token (see details in point API Authentication)
login	your user to login to SMSEagle (see details in point API Authentication)
pass	your password to login to SMSEagle
folder	one of the following: inbox, outbox, sentitems
idfrom	minimal id of message
idto	maximal id of message
responsetype	<i>(optional parameter)</i> text = format response as text (default), xml = format response as XML object

EXAMPLES:

Delete message with id=1234 from inbox:

```
https://url-of-smseagle/http_api/delete_sms?
access_token=0005gOjCOlMH8F2x&folder=inbox&idfrom=1234&idto=1234
```

Delete messages with id 1234 - 1250 from inbox:

```
https://url-of-smseagle/http_api/delete_sms?
access_token=0005gOjCOlMH8F2x&folder=inbox&idfrom=1234&idto=1250
```

Delete all messages from outbox:

```
https://url-of-smseagle/http_api/delete_sms?
access_token=0005gOjCOlMH8F2x&folder=outbox&idfrom=1&idto=999999999
```

RESPONSE:

Response: **OK**

Response (when delete operation was not successful): **Error**

Response (when wrong logindata): **Invalid login or password**

Response (when wrong access token): **Invalid access token**

RESPONSE (XML):

Response:

```
<xml>
  <status>ok</status>
```

```
</xml>
```

Response (when delete operation was not successful):

```
<xml>  
  <status>error</status>  
</xml>
```

Response (when wrong logindata):

```
<xml>  
  <error_text>Invalid login or password</error_text>  
  <status>error</status>  
</xml>
```

Response (when wrong access token):

```
<xml>  
  <error_text>Invalid Access token</error_text>  
  <status>error</status>  
</xml>
```

14. Delete SMS: JSONRPC method

HTTP POST METHOD:

<https://url-of-smseagle/jsonrpc/sms>

Parameter	Description
access_token	authentication access token (see details in point API Authentication)
login	your user to login to SMSEagle (see details in point API Authentication)
pass	your password to login to SMSEagle
folder	one of the following: inbox, outbox, sentitems
idfrom	minimal id of message
idto	maximal id of message
responsetype	<i>(optional parameter)</i> simple = format response as simple object with one result field (default), extended = format response as extended JSON object

EXAMPLES:

Delete message with id=1234 from inbox:

```
{"method":"sms.delete_sms",  
"params":{"access_token":"0005gOjCO1MH8F2x","folder":"inbox","idfrom":"1234"  
"idto":"1234"}}
```

Delete messages with id 1234 - 1250 from inbox:

```
{"method":"sms.delete_sms", "params":{"access_token":  
"0005gOjCO1MH8F2x", "folder":"inbox", "idfrom":"1234", "idto":"1250"}}
```

Delete all messages from outbox:

```
{"method":"sms.delete_sms",
```



```
"params":{"access_token="0005gOjCOlMH8F2x","folder":"outbox","idfrom":"1","idto":"999999999"}}
```

RESPONSE:

Response: {"result": "OK"}

Response (when delete operation was not successful): {"result": "Error"}

Response (when wrong logindata): {"result": "Invalid login or password"}

Response (when wrong access token): {"result": "Invalid access token"}

RESPONSE (EXTENDED):

Response: {"result":{"status":"ok"}}

Response (when delete operation was not successful):

```
{"result":{"status":"error"}}
```

Response (when wrong logindata):

```
{"result": {"error_text":"Invalid login or password","status":"error"}}
```

Response (when wrong access token):

```
{"result": {"error_text":"Invalid access token","status":"error"}}
```

15. Get outgoing queue length: HTTP GET method

HTTP GET METHOD:

https://url-of-smseagle/http_api/get_queue_length

Parameter	Description
access_token	authentication access token (see details in point API Authentication)
Login	your user to login to SMSEagle (see details in point API Authentication)
Pass	your password to login to SMSEagle
Responsetype	<i>(optional parameter)</i> text = format response as text (default), xml = format response as XML object

EXAMPLES:

```
https://url-of-smseagle/http_api/get_queue_length?  
access_token=0005gOjCOlMH8F2x
```

RESPONSE:

Response: **[number of messages in database that wait to be processed by GSM-modem]**

Sample response: 7

Response (when wrong logindata): **Invalid login or password**

Response (when wrong access token): **Invalid access token**

Response (when wrong parameters): **Wrong parameters**

RESPONSE (XML):

Response:

```
<xml>
```

```

<queue_length>
  [number of messages in database that wait to be processed by GSM-modem]
</queue_length >
<status>ok</status>
</xml>

```

Sample response:

```

<xml>
  <queue_length>7</queue_length >
  <status>ok</status>
</xml>

```

Response (when wrong logindata):

```

<xml>
  <error_text>Invalid login or password</error_text>
  <status>error</status>
</xml>

```

Response (when wrong access token):

```

<xml>
  <error_text>Invalid Access token</error_text>
  <status>error</status>
</xml>

```

Response (when wrong parameters):

```

<xml>
  <error_text>Wrong parameters</error_text>
  <status>error</status>
</xml>

```

16. Get outgoing queue length: JSONRPC method

HTTP POST METHOD CALL:

`https://url-of-smseagle/jsonrpc/sms`

Parameter	Description
access_token	authentication access token (see details in point API Authentication)
Login	your user to login to SMSEagle (see details in point API Authentication)
Pass	your password to login to SMSEagle
Responsetype	<i>(optional parameter)</i> simple = format response as simple object with one result field (default), extended = format response as extended JSON object

BODY:

```

{"method": "sms.get_queue_length",
 "params": {"access_token": "0005gOjCO1MH8F2x"}}

```

RESPONSE:

Response: {"result": [number of messages in database that wait to be processed by the modem]}

Sample response: {"result":7}

Response: {"result": "Invalid login or password"}

Response (when wrong access token): {"result": "Invalid access token"}

Response: {"result": "Wrong parameters"}

RESPONSE (EXTENDED):

Response:

```
{"result":{"queue_length":[number of messages in database that wait to be processed by the modem],"status":"ok"}}
```

Sample response: {"result": {"queue_length":"419","status":"ok"}}

Response (when wrong logindata):

```
{"result": {"error_text":"Invalid login or password","status":"error"}}
```

Response (when wrong access token):

```
{"result": {"error_text":"Invalid access token","status":"error"}}
```

Response (when wrong parameters):

```
{"result": {"error_text":"Wrong parameters","status":"error"}}
```

17. Get inbox length: HTTP GET method

HTTP GET METHOD:

https://url-of-smseagle/http_api/get_inbox_length

Parameter	Description
access_token	authentication access token (see details in point API Authentication)
Login	your user to login to SMSEagle (see details in point API Authentication)
Pass	your password to login to SMSEagle
Responsetype	<i>(optional parameter)</i> text = format response as text (default), xml = format response as XML object

EXAMPLES:

https://url-of-smseagle/http_api/get_inbox_length?access_token=0005gOjCO1MH8F2x

RESPONSE:

Response: **[number of messages in database Inbox folder]**

Sample response: 3

Response (when wrong logindata): **Invalid login or password**

Response (when wrong access token): **Invalid access token**

Response (when wrong parameters): **Wrong parameters**

RESPONSE (XML):

Response:

```
<xml>
  <queue_length>
    [number of messages in database Inbox folder]
  </queue_length>
  <status>ok</status>
</xml>
```

Sample response:

```
<xml>
  <inbox_length>3</inbox_length>
  <status>ok</status>
</xml>
```

Response (when wrong logindata):

```
<xml>
  <error_text>Invalid login or password</error_text>
  <status>error</status>
</xml>
```

Response (when wrong access token):

```
<xml>
  <error_text>Invalid Access token</error_text>
  <status>error</status>
</xml>
```

Response (when wrong parameters):

```
<xml>
  <error_text>Wrong parameters</error_text>
  <status>error</status>
</xml>
```

18. Get inbox length: JSONRPC method

HTTP POST METHOD:

<https://url-of-smseagle/jsonrpc/sms>

Parameter	Description
access_token	authentication access token (see details in point API Authentication)
login	your user to login to SMSEagle (see details in point API Authentication)
pass	your password to login to SMSEagle

responsetype	<i>(optional parameter)</i> simple = format response as simple object with one result field (default), extended = format response as extended JSON object
--------------	---

EXAMPLES:

```
{ "method": "sms.get_inbox_length",
  "params": { "access_token": "0005gOjCOlMH8F2x" } }
```

RESPONSE:

Response: {"result": "[number of messages in database Inbox folder]"}

Sample response: 3

Response (when wrong logindata): {"result": "Invalid login or password"}

Response (when wrong access token): {"result": "Invalid access token"}

Response (when wrong parameters): {"result": "Wrong parameters"}

RESPONSE (EXTENDED):

Response:

```
{ "result": { "inbox_length": [number of messages in database Inbox folder], "status": "ok" } }
```

Sample response: {"result": { "inbox_length": "3", "status": "ok" } }

Response (when wrong logindata):

```
{ "result": { "error_text": "Invalid login or password", "status": "error" } }
```

Response (when wrong access token):

```
{ "result": { "error_text": "Invalid access token", "status": "error" } }
```

Response (when wrong parameters):

```
{ "result": { "error_text": "Wrong parameters", "status": "error" } }
```

19. Get sentitems length: HTTP GET method

HTTP GET METHOD:

https://url-of-smseagle/http_api/get_inbox_length

Parameter	Description
access_token	authentication access token (see details in point API Authentication)
login	your user to login to SMSEagle (see details in point API Authentication)
pass	your password to login to SMSEagle
responsetype	<i>(optional parameter)</i> text = format response as text (default), xml = format response as XML object

EXAMPLES:

`https://url-of-smseagle/http_api/get_sentitems_length?access_token=0005gOjCO1MH8F2x`

RESPONSE:

Response: **[number of messages in database Sentitems folder]**

Sample response: 21

Response (when wrong logindata): **Invalid login or password**

Response (when wrong access token): **Invalid access token**

Response (when wrong parameters): **Wrong parameters**

RESPONSE (XML):

Response:

```
<xml>
  <sentitems_length>
    [number of messages in database Inbox folder]
  </sentitems_length>
  <status>ok</status>
</xml>
```

Sample response:

```
<xml>
  <sentitems_length>21</sentitems_length>
  <status>ok</status>
</xml>
```

Response (when wrong logindata):

```
<xml>
  <error_text>Invalid login or password</error_text>
  <status>error</status>
</xml>
```

Response (when wrong access token):

```
<xml>
  <error_text>Invalid Access token</error_text>
  <status>error</status>
</xml>
```

Response (when wrong parameters):

```
<xml>
  <error_text>Wrong parameters</error_text>
  <status>error</status>
</xml>
```

20. Get sentitems length: JSONRPC method

HTTP POST METHOD:

`https://url-of-smseagle/jsonrpc/sms`

Parameter	Description
access_token	authentication access token (see details in point API Authentication)
login	your user to login to SMSEagle (see details in point API Authentication)
pass	your password to login to SMSEagle
responsetype	<i>(optional parameter)</i> simple = format response as simple object with one result field (default), extended = format response as extended JSON object

EXAMPLES:

```
{ "method": "sms.get_sentitems_length",  
  "params": { "access_token": "0005gOjCO1MH8F2x" } }
```

RESPONSE:

Response: {"result": "[number of messages in database Sentitems folder]"}
Sample response: {"result": "21"}

Response (when wrong logindata): {"result": "Invalid login or password"}

Response (when wrong access token): {"result": "Invalid access token"}

Response (when wrong parameters): {"result": "Wrong parameters"}

RESPONSE (EXTENDED):

Response:

```
{ "result": { "sentitems_length": [number of messages in database Sentitems  
folder], "status": "ok" } }
```

Sample response: {"result": { "sentitems_length": "21", "status": "ok" } }

Response (when wrong logindata):

```
{ "result": { "error_text": "Invalid login or password", "status": "error" } }
```

Response (when wrong access token):

```
{ "result": { "error_text": "Invalid access token", "status": "error" } }
```

Response (when wrong parameters):

```
{ "result": { "error_text": "Wrong parameters", "status": "error" } }
```

21. Get 3G/4G signal strength: HTTP GET method

HTTP GET METHOD:

`https://url-of-smseagle/http_api/get_gsm signal`

Parameter	Description
access_token	authentication access token (see details in point API Authentication)
login	your user to login to SMSEagle (see details in point API Authentication)
pass	your password to login to SMSEagle
modem_no	<i>(optional parameter)</i> modem number to be queried (default = 1). Used only in multimodem devices
responsetype	<i>(optional parameter)</i> text = format response as text (default), xml = format response as XML object

EXAMPLES:

```
https://url-of-smseagle/http_api/get_gsmsignal?
access_token=0005gOjCO1MH8F2x&modem_no=1
```

RESPONSE:

Response: **3G/4G signal strength in percent (values between 0-100)**. If 3G/4G modem is disconnected from cellular network, method returns -1

Sample response: 74

Response (when wrong logindata): **Invalid login or password**

Response (when wrong access token): **Invalid access token**

Response (when wrong parameters): **Wrong parameters**

RESPONSE (XML):

Response:

```
<xml>
  <signal_strength>
    [GSM signal strength in percent (values between 0-100)]
  </signal_strength>
  <status>ok</status>
</xml>
```

Sample response:

```
<xml>
  <signal_strength>74</signal_strength>
  <status>ok</status>
</xml>
```

Response (when wrong logindata):

```
<xml>
  <error_text>Invalid login or password</error_text>
  <status>error</status>
</xml>
```

Response (when wrong access token):

```
<xml>
  <error_text>Invalid Access token</error_text>
  <status>error</status>
</xml>
```

Response (when wrong parameters):

```
<xml>
  <error_text>Wrong parameters</error_text>
  <status>error</status>
</xml>
```

22. Get 3G/4G signal strength: JSONRPC method

HTTP POST METHOD CALL:

<https://url-of-smseagle/jsonrpc/sms>

Parameter	Description
access_token	authentication access token (see details in point API Authentication)
login	your user to login to SMSEagle (see details in point API Authentication)
pass	your password to login to SMSEagle
modem_no	<i>(optional parameter)</i> modem number to be queried (default = 1). Used only in multimodem devices
responsetype	<i>(optional parameter)</i> simple = format response as simple object with one result field (default), extended = format response as extended JSON object

BODY:

```
{"method": "signal.get_gsm_signal",
"params": {"access_token": "0005gOjCO1MH8F2x"}}
```

RESPONSE:

Response: {"result": 3G/4G signal strength in percent: values between 0-100. If 3G/4G modem is disconnected from cellular network, method returns -1 }

Sample response: {"result": 7}

Response: {"result": "Invalid login or password"}

Response (when wrong access token): {"result": "Invalid access token"}

Response: {"result": "Wrong parameters"}

RESPONSE (EXTENDED):

Response:

```
{"result": {"signal_strength": [number of messages in database Sentitems folder], "status": "ok"}}
```

Sample response: {"result": {"signal_strength": "7", "status": "ok"}}

Response (when wrong logindata):

```
{"result": {"error_text": "Invalid login or password", "status": "error"}}
```

Response (when wrong access token):

```
{"result": {"error_text": "Invalid access token", "status": "error"}}
```

23. Phonebook group create: HTTP GET method

HTTP GET METHOD:

https://url-of-smseagle/http_api/group_create

Parameter	Description
access_token	authentication access token (see details in point API Authentication)
login	your user to login to SMSEagle (see details in point API Authentication)
pass	your password to login to SMSEagle
groupname	name for the created group
public	<i>(optional parameter)</i> 0 = private group, 1 = public group
responsetype	<i>(optional parameter)</i> text = format response as text (default), xml = format response as XML object

EXAMPLES:

```
https://url-of-smseagle/http_api/group_create?  
access_token=0005gOjCOlMH8F2x&groupname=myusers&public=1
```

RESPONSE:

Response: **OK; ID=[ID of created group]**

Sample response: OK; ID=5

Response (when wrong logindata): **Invalid login or password**

Response (when wrong access token): **Invalid access token**

Response (when wrong parameters): **Wrong or missing >>groupname<< parameter**

RESPONSE (XML):

Response:

```
<xml>  
  <group_id>[ID of created group]</group_id>  
  <status>ok</status>  
</xml>
```

Sample response:

```
<xml>
  <group_id>5</group_id>
  <status>ok</status>
</xml>
```

Response (when wrong logindata):

```
<xml>
  <error_text>Invalid login or password</error_text>
  <status>error</status>
</xml>
```

Response (when wrong access token):

```
<xml>
  <error_text>Invalid Access token</error_text>
  <status>error</status>
</xml>
```

Response (when wrong parameters):

```
<xml>
  <error_text>Wrong or missing >>groupname<< parameter</error_text>
  <status>error</status>
</xml>
```

24. Phonebook group create: JSONRPC method

HTTP POST METHOD:

<https://url-of-smseagle/jsonrpc/sms>

Parameter	Description
access_token	authentication access token (see details in point API Authentication)
login	your user to login to SMSEagle (see details in point API Authentication)
pass	your password to login to SMSEagle
groupname	name for the created group
public	<i>(optional parameter)</i> 0 = private group, 1 = public group
responsetype	<i>(optional parameter)</i> simple = format response as simple object with one result field (default), extended = format response as extended JSON object

EXAMPLES:

```
{ "method": "phonebook.group_create",
  "params": { "access_token": "0005gOjCO1MH8F2x", "groupname": "myusers", "public": "1" } }
```

RESPONSE:

Response: {"result": "OK; ID=[ID of created group]"}

Sample response: {"result": "OK; ID=5"}

Response (when wrong logindata): {"result": "Invalid login or password"}

Response (when wrong access token): {"result": "Invalid access token"}

Response (when wrong parameters): {"result": "Wrong or missing >>groupname<< parameter"}

RESPONSE (EXTENDED):

Response:

```
{"result": {"group_id":"[ID of created group]","status":"ok"}}
```

Sample response: {"result": {"group_id":"748","status":"ok"}}

Response (when wrong logindata):

```
{"result": {"error_text":"Invalid login or password","status":"error"}}
```

Response (when wrong access token):

```
{"result": {"error_text":"Invalid access token","status":"error"}}
```

Response (when wrong parameters):

```
{"result": {"error_text":"Wrong parameters","status":"error"}}
```

25. Phonebook group read: HTTP GET method

HTTP GET METHOD:

https://url-of-smseagle/http_api/group_read

Parameter	Description
access_token	authentication access token (see details in point API Authentication)
login	your user to login to SMSEagle (see details in point API Authentication)
pass	your password to login to SMSEagle
public	<i>(optional parameter)</i> 0 = private group (default value), 1 = public group
uid	<i>(optional parameter)</i> id of user who created the group
responsetype	<i>(optional parameter)</i> text = format response as text (default), xml = format response as XML object

EXAMPLES:

```
https://url-of-smseagle/http_api/group_read?  
access_token=0005gOjCO1MH8F2x&public=1&uid=12
```

RESPONSE:

Sample response: [link](#)

Response (when no data): **No data to display**

Response (when wrong logindata): **Invalid login or password**

Response (when wrong access token): **Invalid access token**

Response (when wrong parameters):

Wrong or missing >>uid<< parameter

Wrong or missing >>public<< parameter

RESPONSE (XML):

Sample response:

```
<xml>
<groups>
<item>
  <Name>private</Name>
  <ID>2</ID>
  <id_user>2</id_user>
  <is_public>true</is_public>
</item>
<item>
  <Name>Everyone</Name>
  <ID>3</ID>
  <id_user>1</id_user>
  <is_public>true</is_public>
</item>
<item>
  <Name>work</Name>
  <ID>4</ID>
  <id_user>1</id_user>
  <is_public>true</is_public>
</item></groups>
<status>ok</status>
</xml>
```

Response (when no data):

```
<xml>
  <error_text>No data to display</error_text>
  <status>error</status>
</xml>
```

Response (when wrong logindata):

```
<xml>
  <error_text>Invalid login or password</error_text>
  <status>error</status>
</xml>
```

Response (when wrong access token):

```
<xml>
  <error_text>Invalid Access token</error_text>
  <status>error</status>
</xml>
```

Response (when wrong parameters):

```
<xml>
  <error_text>Wrong or missing >>uid<< parameter</error_text>
  <status>error</status>
</xml>
```

Response (when wrong parameters):

```
<xml>
  <error_text>Wrong or missing >>public<< parameter</error_text>
  <status>error</status>
</xml>
```

26. Phonebook group read: JSONRPC method

HTTP POST METHOD:

<https://url-of-smseagle/jsonrpc/sms>

Parameter	Description
access_token	authentication access token (see details in point API Authentication)
login	your user to login to SMSEagle (see details in point API Authentication)
pass	your password to login to SMSEagle
public	<i>(optional parameter)</i> 0 = private group (default value), 1 = public group
uid	<i>(optional parameter)</i> id of user who created the group
responsetype	<i>(optional parameter)</i> simple = format response as simple object with one result field (default), extended = format response as extended JSON object

EXAMPLES:

```
{"method": "phonebook.group_read",
"params": {"access_token": "0005g0jCO1MH8F2x", "public": "1", "uid": "12"}}
```

RESPONSE:

Sample response:

```
{"result": [
  {"Name": "private", "ID": "2", "id_user": "1", "is_public": "true"},
  {"Name": "Everyone", "ID": "3", "id_user": "1", "is_public": "true"},
  {"Name": "work", "ID": "4", "id_user": "2", "is_public": "true"}
]}
```

Response (when no data): {"result": "No data to display"}

Response (when wrong logindata): {"result": "Invalid login or password"}

Response (when wrong access token): {"result": "Invalid access token"}

Response (when wrong parameters):

```
{"result": "Wrong or missing >>uid<< parameter"}
{"result": "Wrong or missing >>public<< parameter"}
```

RESPONSE (EXTENDED):

Sample response:

```
{"result": [{"groups": [{"Name": "private", "ID": "2", "id_user": "1", "is_public": "true"}, {"Name": "Everyone", "ID": "3", "id_user": "1", "is_public": "true"}, {"Name": "work", "ID": "4", "id_user": "2", "is_public": "true"}], "status": "ok"}}
```

Response (when no data):

```
{"result": {"error_text": " No data to display", "status": "error"}}
```

Response (when wrong logindata):

```
{"result": {"error_text": "Invalid login or password", "status": "error"}}
```

Response (when wrong access token):

```
{"result": {"error_text": "Invalid access token", "status": "error"}}
```

Response (when wrong parameters):

```
{"result": {"error_text": "Wrong or missing >>uid<< parameter", "status": "error"}}
```

```
{"result": {"error_text": "Wrong or missing >>public<< parameter", "status": "error"}}
```

27. Phonebook group update: HTTP GET method

HTTP GET METHOD:

https://url-of-smseagle/http_api/group_update

Parameter	Description
access_token	authentication access token (see details in point API Authentication)
login	your user to login to SMSEagle (see details in point API Authentication)
pass	your password to login to SMSEagle
group_id	id of existing group
groupname	name for the group
public	<i>(optional parameter)</i> 0 = private group, 1 = public group
responsetype	<i>(optional parameter)</i> text = format response as text (default), xml = format response as XML object

EXAMPLES:

```
https://url-of-smseagle/http_api/group_update?  
access_token=0005gOjCOlMH8F2x&group_id=2&groupname=myusers&public=1
```

RESPONSE:

Response: **OK**

Response (when wrong logindata): **Invalid login or password**

Response (when wrong access token): **Invalid access token**

Response (when wrong parameters):

Wrong or missing >>groupname<< parameter

Wrong or missing >>group_id<< parameter

Response (when group_id is wrong): **Group with the given id does not exists**

RESPONSE (XML):

Response:

```
<xml>
  <status>ok</status>
</xml>
```

Response (when wrong logindata):

```
<xml>
  <error_text>Invalid login or password</error_text>
  <status>error</status>
</xml>
```

Response (when wrong access token):

```
<xml>
  <error_text>Invalid Access token</error_text>
  <status>error</status>
</xml>
```

Response (when wrong parameters):

```
<xml>
  <error_text>Wrong or missing >>groupname<< parameter</error_text>
  <status>error</status>
</xml>
```

```
<xml>
  <error_text>Wrong or missing >>group_id<< parameter</error_text>
  <status>error</status>
</xml>
```

Response (when group_id is wrong):

```
<xml>
  <error_text>Group with the given id does not exists</error_text>
  <status>error</status>
</xml>
```

28. Phonebook group update: JSONRPC method

HTTP POST METHOD:

https://url-of-smseagle/jsonrpc/sms

Parameter	Description
access_token	authentication access token (see details in point API Authentication)
login	your user to login to SMSEagle (see details in point API Authentication)
pass	your password to login to SMSEagle
group_id	id of existing group
groupname	name for the group
public	<i>(optional parameter)</i> 0 = private group, 1 = public group
responsetype	<i>(optional parameter)</i> simple = format response as simple object with one result field (default), extended = format response as extended JSON object

EXAMPLES:

```
{"method": "phonebook.group_update",  
"params": {"access_token": "0005gOjCOlMH8F2x", "group_id": "2", "groupname": "myusers", "public": "1"}}
```

RESPONSE:

Response: {"result": "OK"}

Response (when wrong logindata): {"result": "Invalid login or password"}

Response (when wrong access token): {"result": "Invalid access token"}

Response (when wrong parameters):

```
{"result": "Wrong or missing >>groupname<< parameter"}
```

```
{"result": "Wrong or missing >>group_id<< parameter"}
```

Response (when group_id is wrong): {"result": "Group with the given id does not exists"}

RESPONSE (EXTENDED):

Response: {"result": {"status": "ok"}}

Response (when wrong logindata):

```
{"result": {"error_text": "Invalid login or password", "status": "error"}}
```

Response (when wrong access token):

```
{"result": {"error_text": "Invalid access token", "status": "error"}}
```

Response (when wrong parameters):

```
{"result": {"error_text": "Wrong or missing >>groupname<< parameter", "status": "error"}}
```

```
{"result": {"error_text": "Wrong or missing >>group_id<< parameter", "status": "error"}}
```

Response (when group_id is wrong):

```
{"result": {"error_text": "Group with the given id does not exists", "status": "error"}}
```

29. Phonebook group delete: HTTP GET method

HTTP GET METHOD:

https://url-of-smseagle/http_api/group_delete

Parameter	Description
access_token	authentication access token (see details in point API Authentication)
login	your user to login to SMSEagle (see details in point API Authentication)
pass	your password to login to SMSEagle
group_id	id of existing group
groupname	name of existing group
responsetype	<i>(optional parameter)</i> text = format response as text (default), xml = format response as XML object

EXAMPLES:

```
https://url-of-smseagle/http_api/group_delete?  
access_token=0005gOjCOlMH8F2x&group_id=2&groupname=myusers
```

RESPONSE:

Response: **OK**

Response (when wrong logindata): **Invalid login or password**

Response (when wrong access token): **Invalid access token**

Response (when wrong parameters):

Wrong or missing >>groupname<< parameter

Wrong or missing >>group_id<< parameter

Response (when group_id is wrong): **Group with the given id and name does not exist**

RESPONSE (XML):

Response:

```
<xml>  
  <status>ok</status>  
</xml>
```

Response (when wrong logindata):

```
<xml>  
  <error_text>Invalid login or password</error_text>  
  <status>error</status>  
</xml>
```

Response (when wrong access token):

```
<xml>
  <error_text>Invalid Access token</error_text>
  <status>error</status>
</xml>
```

Response (when wrong parameters):

```
<xml>
  <error_text>Wrong or missing >>groupname<< parameter</error_text>
  <status>error</status>
</xml>
```

```
<xml>
  <error_text>Wrong or missing >>group_id<< parameter</error_text>
  <status>error</status>
</xml>
```

Response (when group_id is wrong):

```
<xml>
  <error_text>Group with the given id does not exists</error_text>
  <status>error</status>
</xml>
```

30. Phonebook group delete: JSONRPC method

HTTP POST METHOD:

<https://url-of-smseagle/jsonrpc/sms>

Parameter	Description
access_token	authentication access token (see details in point API Authentication)
login	your user to login to SMSEagle (see details in point API Authentication)
pass	your password to login to SMSEagle
group_id	id of existing group
groupname	name of existing group
responsetype	<i>(optional parameter)</i> simple = format response as simple object with one result field (default), extended = format response as extended JSON object

EXAMPLES:

```
{"method": "phonebook.group_delete",
"params": {"access_token": "0005gOjCO1MH8F2x", "group_id": "2", "groupname": "myusers"}}
```

RESPONSE:

```
Response: {"result": "OK"}
```

Response (when wrong logindata): {"result": "Invalid login or password"}

Response (when wrong access token): {"result": "Invalid access token"}

Response (when wrong parameters):

```
{"result": "Wrong or missing >>groupname<< parameter"}
```

```
{"result": "Wrong or missing >>group_id<< parameter"}
```

Response (when group_id is wrong): {"result": "Group with the given id and name does not exist"}

RESPONSE (EXTENDED):

Response: {"result":{"status":"ok"}}

Response (when wrong logindata):

```
{"result": {"error_text":"Invalid login or password","status":"error"}}
```

Response (when wrong access token):

```
{"result": {"error_text":"Invalid access token","status":"error"}}
```

Response (when wrong parameters):

```
{"result": {"error_text":"Wrong or missing >>groupname<< parameter","status":"error"}}
```

```
{"result": {"error_text":"Wrong or missing >>group_id<< parameter","status":"error"}}
```

Response (when group_id is wrong):

```
{"result": {"error_text":"Group with the given id does not exists","status":"error"}}
```

31. Phonebook group add contact: HTTP GET method

HTTP GET METHOD:

https://url-of-smseagle/http_api/group_addcontact

Parameter	Description
access_token	authentication access token (see details in point API Authentication)
login	your user to login to SMSEagle (see details in point API Authentication)
pass	your password to login to SMSEagle
group_id	id of existing group (or id's separated with comma)
contact_id	id of contact. The contact will be added to the group
responsetype	<i>(optional parameter)</i> text = format response as text (default), xml = format response as XML object

EXAMPLES:

```
https://url-of-smseagle/http_api/group_addcontact?  
access_token=0005gOjCOlMH8F2x&group_id=2&contact_id=1
```

RESPONSE:

Response: **OK**

Response (when wrong logindata): **Invalid login or password**

Response (when wrong access token): **Invalid access token**

Response (when wrong parameters):

Wrong or missing >>group_id<< parameter

Wrong or missing >>contact_id<< parameter

Response (when id is wrong):

Group with the given id does not exists

Contact with the given id does not exists

RESPONSE (XML):

Response:

```
<xml>
  <status>ok</status>
</xml>
```

Response (when wrong logindata):

```
<xml>
  <error_text>Invalid login or password</error_text>
  <status>error</status>
</xml>
```

Response (when wrong access token):

```
<xml>
  <error_text>Invalid Access token</error_text>
  <status>error</status>
</xml>
```

Response (when wrong parameters):

```
<xml>
  <error_text>Wrong or missing >>group_id<< parameter</error_text>
  <status>error</status>
</xml>
```

```
<xml>
  <error_text>Wrong or missing >>contact_id<< parameter</error_text>
  <status>error</status>
</xml>
```

Response (when id is wrong):

```
<xml>
  <error_text>Group with the given id does not exists</error_text>
  <status>error</status>
</xml>
```

```
<xml>
  <error_text>Contact with the given id does not exists</error_text>
  <status>error</status>
</xml>
```

32. Phonebook group add contact: JSONRPC method

HTTP POST METHOD:

<https://url-of-smseagle/jsonrpc/sms>

Parameter	Description
access_token	authentication access token (see details in point API Authentication)
login	your user to login to SMSEagle (see details in point API Authentication)
pass	your password to login to SMSEagle
group_id	id of existing group (or id's separated with comma)
contact_id	id of contact. The contact will be added to the group
responsetype	<i>(optional parameter)</i> simple = format response as simple object with one result field (default), extended = format response as extended JSON object

EXAMPLES:

```
{ "method": "phonebook.group_addcontact",
  "params": { "access_token": "0005gOjCOlMH8F2x", "group_id": "2", "contact_id": "1"
} }
```

RESPONSE:

Response: {"result": "OK"}

Response (when wrong logindata): {"result": "Invalid login or password"}

Response (when wrong access token): {"result": "Invalid access token"}

Response (when wrong parameters):

```
{ "result": "Wrong or missing >>group_id<< parameter" }
{ "result": "Wrong or missing >>contact_id<< parameter" }
```

Response (when id is wrong):

```
{ "result": "Group with the given id does not exists" }
{ "result": "Contact with the given id does not exists" }
```

RESPONSE (EXTENDED):

Response: {"result": {"status": "ok"}}

Response (when wrong logindata):

```
{ "result": { "error_text": "Invalid login or password", "status": "error" } }
```

Response (when wrong access token):

```
{"result": {"error_text": "Invalid access token", "status": "error"}}
```

Response (when wrong parameters):

```
{"result": {"error_text": "Wrong or missing >>group_id<<  
parameter", "status": "error"}}
```

```
{"result": {"error_text": "Wrong or missing >>contact_id<<  
parameter", "status": "error"}}
```

Response (when id is wrong):

```
{"result": {"error_text": "Group with the given id does not  
exists", "status": "error"}}
```

```
{"result": {"error_text": "Contact with the given id does not  
exists", "status": "error"}}
```

33. Phonebook group remove contact: HTTP GET method

HTTP GET METHOD:

https://url-of-smseagle/http_api/group_removecontact

Parameter	Description
access_token	authentication access token (see details in point API Authentication)
login	your user to login to SMSEagle (see details in point API Authentication)
pass	your password to login to SMSEagle
group_id	id of existing group (or id's separated with comma)
contact_id	id of contact. The contact will be removed from the group
responsetype	<i>(optional parameter)</i> text = format response as text (default), xml = format response as XML object

EXAMPLES:

```
https://url-of-smseagle/http_api/group_removecontact?  
access_token=0005gOjCOlMH8F2x&group_id=2&contact_id=1
```

RESPONSE:

Response: **OK**

Response (when wrong logindata): **Invalid login or password**

Response (when wrong access token): **Invalid access token**

Response (when wrong parameters):

Wrong or missing >>group_id<< parameter

Wrong or missing >>contact_id<< parameter

Response (when id is wrong):

Group with the given id does not exists

Contact with the given id does not exists

RESPONSE (XML):

Response:

```
<xml>  
  <status>ok</status>  
</xml>
```

Response (when wrong logindata):

```
<xml>  
  <error_text>Invalid login or password</error_text>  
  <status>error</status>  
</xml>
```

Response (when wrong access token):

```
<xml>  
  <error_text>Invalid Access token</error_text>  
  <status>error</status>  
</xml>
```

Response (when wrong parameters):

```
<xml>  
  <error_text>Wrong or missing >>group_id<< parameter</error_text>  
  <status>error</status>  
</xml>
```

```
<xml>  
  <error_text>Wrong or missing >>contact_id<< parameter</error_text>  
  <status>error</status>  
</xml>
```

Response (when id is wrong):

```
<xml>  
  <error_text>Group with the given id does not exists</error_text>  
  <status>error</status>  
</xml>
```

```
<xml>  
  <error_text>Contact with the given id does not exists</error_text>  
  <status>error</status>  
</xml>
```

34. Phonebook group remove contact: JSONRPC method

HTTP POST METHOD:

https://url-of-smseagle/jsonrpc/sms

Parameter	Description
access_token	authentication access token (see details in point API Authentication)
login	your user to login to SMSEagle (see details in point API Authentication)
pass	your password to login to SMSEagle
group_id	id of existing group (or id's separated with comma)
contact_id	id of contact. The contact will be removed from the group
responsetype	<i>(optional parameter)</i> simple = format response as simple object with one result field (default), extended = format response as extended JSON object

EXAMPLES:

```
{ "method": "phonebook.group_removecontact",  
  "params": { "access_token": "0005gOjCOlMH8F2x", "group_id": "2", "contact_id": "1"  
} }
```

RESPONSE:

Response: {"result": "OK"}

Response (when wrong logindata): {"result": "Invalid login or password"}

Response (when wrong access token): {"result": "Invalid access token"}

Response (when wrong parameters):

```
{"result": "Wrong or missing >>group_id<< parameter"}
```

```
{"result": "Wrong or missing >>contact_id<< parameter"}
```

Response (when id is wrong):

```
{"result": "Group with the given id does not exists"}
```

```
{"result": "Contact with the given id does not exists"}
```

RESPONSE (EXTENDED):

Response: {"result": {"status": "ok"}}

Response (when wrong logindata):

```
{"result": {"error_text": "Invalid login or password", "status": "error"}}
```

Response (when wrong access token) :

```
{"result": {"error_text": "Invalid access token", "status": "error"}}
```

Response (when wrong parameters):

```
{"result": {"error_text": "Wrong or missing >>group_id<<  
parameter", "status": "error"}}
```

```
{"result": {"error_text": "Wrong or missing >>contact_id<<  
parameter", "status": "error"}}
```

Response (when id is wrong):

```
{"result": {"error_text": "Group with the given id does not exists", "status": "error"}}
```

```
{"result": {"error_text": "Contact with the given id does not exists", "status": "error"}}
```

35. Phonebook contact create: HTTP GET method

HTTP GET METHOD:

https://url-of-smseagle/http_api/contact_create

Parameter	Description
access_token	authentication access token (see details in point API Authentication)
login	your user to login to SMSEagle (see details in point API Authentication)
pass	your password to login to SMSEagle
contactname	name for the created contact
number	telephone number for the created contact
public	<i>(optional parameter)</i> 0 = private contact, 1 = public contact (default value)
responsetype	<i>(optional parameter)</i> text = format response as text (default), xml = format response as XML object

EXAMPLES:

```
https://url-of-smseagle/http_api/contact_create?  
access_token=0005gOjCO1MH8F2x&contactname=johndoe&number=12345678&public=1
```

RESPONSE:

Response: **OK; ID=[ID of created contact]**

Sample response: OK; ID=2

Response (when wrong logindata): **Invalid login or password**

Response (when wrong access token): **Invalid access token**

Response (when wrong parameters):

Wrong or missing >>contactname<< parameter

Wrong or missing >>number<< parameter

RESPONSE (XML):

Response:

```
<xml>  
  <contact_id>[ID of created contact]</contact_id>  
  <status>ok</status>  
</xml>
```

Sample response:

```
<xml>
  <contact_id>2</contact_id>
  <status>ok</status>
</xml>
```

Response (when wrong logindata):

```
<xml>
  <error_text>Invalid login or password</error_text>
  <status>error</status>
</xml>
```

Response (when wrong access token):

```
<xml>
  <error_text>Invalid Access token</error_text>
  <status>error</status>
</xml>
```

Response (when wrong parameters):

```
<xml>
  <error_text>Wrong or missing >>contactname<< parameter</error_text>
  <status>error</status>
</xml>
```

```
<xml>
  <error_text>Wrong or missing >>number<< parameter</error_text>
  <status>error</status>
</xml>
```

36. Phonebook contact create: JSONRPC method

HTTP POST METHOD:

<https://url-of-smseagle/jsonrpc/sms>

Parameter	Description
access_token	authentication access token (see details in point API Authentication)
login	your user to login to SMSEagle (see details in point API Authentication)
pass	your password to login to SMSEagle
contactname	name for the created contact
number	telephone number for the created contact
public	<i>(optional parameter)</i> 0 = private contact 1 = public contact (default value)
responsetype	<i>(optional parameter)</i> simple = format response as simple object with one result field (default), extended = format response as extended JSON object

EXAMPLES:

```
{"method": "phonebook.contact_create",  
"params": {"access_token": "0005gOjCOlMH8F2x", "contactname": "johndoe", "number": "12345678", "public": "1"}}
```

RESPONSE:

Response: {"result": "OK; ID=[ID of created contact]"}

Sample response: {"result": "OK; ID=2"}

Response (when wrong logindata): {"result": "Invalid login or password"}

Response (when wrong access token): {"result": "Invalid access token"}

Response (when wrong parameters):

```
{"result": "Wrong or missing >>contactname<< parameter"}
```

```
{"result": "Wrong or missing >>number<< parameter"}
```

RESPONSE (EXTENDED):

Response:

```
{"result": {"contact_id": "[ID of created contact]", "status": "ok"}}
```

Sample response: {"result": {"contact_id": "2", "status": "ok"}}

Response (when wrong logindata):

```
{"result": {"error_text": "Invalid login or password", "status": "error"}}
```

Response (when wrong access token):

```
{"result": {"error_text": "Invalid access token", "status": "error"}}
```

Response (when wrong parameters):

```
{"result": {"error_text": "Wrong or missing >>contactname<<  
parameter"}, "status": "error"}}
```

```
{"result": {"error_text": "Wrong or missing >>number<<  
parameter", "status": "error"}}
```

37. Phonebook contact read: HTTP GET method

HTTP GET METHOD:

https://url-of-smseagle/http_api/contact_read

Parameter	Description
access_token	authentication access token (see details in point API Authentication)
login	your user to login to SMSEagle (see details in point API Authentication)
pass	your password to login to SMSEagle
public	<i>(optional parameter)</i> 0 = private contacts (default value), 1 = public contacts
uid	<i>(optional parameter)</i> id of user who created the contact

responsetype	(optional parameter) text = format response as text (default), xml = format response as XML object
--------------	--

EXAMPLES:

https://url-of-smseagle/http_api/contact_read?
access_token=0005gOjCOlMH8F2x&public=1&uid=12

RESPONSE:

Sample response: [link](#)

Response (when no data): **No data to display**

Response (when wrong logindata): **Invalid login or password**

Response (when wrong access token): **Invalid access token**

Response (when wrong parameters):

Wrong or missing >>uid<< parameter

Wrong or missing >>public<< parameter

RESPONSE (XML):

Sample response:

```
<xml>
<contacts>
<item>
<ID>2</ID>
<GroupID>-1</GroupID>
<Name>John Doe</Name>
<Number>123123123</Number>
<id_user>1</id_user>
<is_public>>true</is_public>
</item>
<item>
<ID>4</ID>
<GroupID>-1</GroupID>
<Name>Jan Nowak</Name>
<Number>4215456456</Number>
<id_user>1</id_user>
<is_public>>true</is_public>
</item>
<item>
<ID>5</ID>
<GroupID>-1</GroupID>
<Name>Andy</Name>
<Number>+44 1234 155931</Number>
<id_user>1</id_user>
<is_public>>true</is_public>
```

```

</item>
</contacts>
<status>ok</status>
</xml>

```

Response (when no data):

```

<xml>
  <error_text>No data to display</error_text>
  <status>error</status>
</xml>

```

Response (when wrong logindata):

```

<xml>
  <error_text>Invalid login or password</error_text>
  <status>error</status>
</xml>

```

Response (when wrong access token):

```

<xml>
  <error_text>Invalid Access token</error_text>
  <status>error</status>
</xml>

```

Response (when wrong parameters):

```

<xml>
  <error_text>Wrong or missing >>uid<< parameter</error_text>
  <status>error</status>
</xml>

```

```

<xml>
  <error_text>Wrong or missing >>public<< parameter</error_text>
  <status>error</status>
</xml>

```

38. Phonebook contact read: JSONRPC method

HTTP POST METHOD:

<https://url-of-smseagle/jsonrpc/sms>

Parameter	Description
access_token	authentication access token (see details in point API Authentication)
login	your user to login to SMSEagle (see details in point API Authentication)
pass	your password to login to SMSEagle
public	<i>(optional parameter)</i> 0 = private contacts (default value), 1 = public contacts
uid	<i>(optional parameter)</i> id of user who created the contact

responsetype	(optional parameter) simple = format response as simple object with one result field (default), extended = format response as extended JSON object
--------------	--

EXAMPLES:

```
{ "method": "phonebook.contact_read",
  "params": { "access_token": "0005gOjCO1MH8F2x", "public": "1", "uid": "12" } }
```

RESPONSE:

Sample response:

```
{ "result": [
  { "ID": "2", "GroupID": "-1", "Name": "John
  Doe", "Number": "123123123", "id_user": "1", "is_public": "false" },
  { "ID": "4", "GroupID": "-1", "Name": "Jan
  Nowak", "Number": "4215456456", "id_user": "1", "is_public": "false" },
  { "ID": "5", "GroupID": "-
  1", "Name": "Andy", "Number": "+441234155931", "id_user": "1", "is_public": "false"
  }
  ] }
```

Response (when no data): { "result": "No data to display" }

Response (when wrong logindata): { "result": "Invalid login or password" }

Response (when wrong access token): { "result": "Invalid access token" }

Response (when wrong parameters):

```
{ "result": "Wrong or missing >>uid<< parameter" }
{ "result": "Wrong or missing >>public<< parameter" }
```

RESPONSE (EXTENDED):

Sample response:

```
{ "result": { "contacts": [
  { "ID": "2", "GroupID": "-1", "Name": "John
  Doe", "Number": "123123123", "id_user": "1", "is_public": "false" },
  { "ID": "4", "GroupID": "-1", "Name": "Jan
  Nowak", "Number": "4215456456", "id_user": "1", "is_public": "false" },
  { "ID": "5", "GroupID": "-
  1", "Name": "Andy", "Number": "+441234155931", "id_user": "1", "is_public": "false"
  }
  ], "status": "ok" } }
```

Response (when no data):

```
{ "result": { "error_text": " No data to display", "status": "error" } }
```

Response (when wrong logindata):

```
{ "result": { "error_text": "Invalid login or password", "status": "error" } }
```

Response (when wrong access token):

```
{"result": {"error_text": "Invalid access token", "status": "error"}}
```

Response (when wrong parameters):

```
{"result": {"error_text": "Wrong or missing >>uid<<  
parameter", "status": "error"}}
```

```
{"result": {"error_text": "Wrong or missing >>public<<  
parameter", "status": "error"}}
```

39. Phonebook contact update: HTTP GET method

HTTP GET METHOD:

https://url-of-smseagle/http_api/contact_update

Parameter	Description
access_token	authentication access token (see details in point API Authentication)
login	your user to login to SMSEagle (see details in point API Authentication)
pass	your password to login to SMSEagle
contact_id	id of existing contact
contactname	name for the contact
number	phone number for the contact
public	<i>(optional parameter)</i> 0 = private group, 1 = public group
responsetype	<i>(optional parameter)</i> text = format response as text (default), xml = format response as XML object

EXAMPLES:

```
https://url-of-smseagle/http_api/contact_update?  
access_token=0005gOjCOlMH8F2x&contact_id=4&contactname=johnlord&number=1234  
56789&public=1
```

RESPONSE:

Response: **OK**

Response (when wrong logindata): **Invalid login or password**

Response (when wrong access token): **Invalid access token**

Response (when wrong parameters):

Wrong or missing >>contactname<< parameter

Wrong or missing >>contact_id<< parameter

Wrong or missing >>number<< parameter

Response (when contact_id is wrong): **Contact with the given id does not exists**

RESPONSE (XML):

Response:

```
<xml>
  <status>ok</status>
</xml>
```

Response (when wrong logindata):

```
<xml>
  <error_text>Invalid login or password</error_text>
  <status>error</status>
</xml>
```

Response (when wrong access token):

```
<xml>
  <error_text>Invalid Access token</error_text>
  <status>error</status>
</xml>
```

Response (when wrong parameters):

```
<xml>
  <error_text>Wrong or missing >>contactname<< parameter</error_text>
  <status>error</status>
</xml>
```

```
<xml>
  <error_text>Wrong or missing >>contact_id<< parameter</error_text>
  <status>error</status>
</xml>
```

```
<xml>
  <error_text>Wrong or missing >>number<< parameter</error_text>
  <status>error</status>
</xml>
```

Response (when contact_id is wrong):

```
<xml>
  <error_text>Contact with the given id does not exists</error_text>
  <status>error</status>
</xml>
```

40. Phonebook contact update: JSONRPC method

HTTP POST METHOD:

<https://url-of-smseagle/jsonrpc/sms>

Parameter	Description
access_token	authentication access token (see details in point API Authentication)
login	your user to login to SMSEagle (see details in point API Authentication)
pass	your password to login to SMSEagle
contact_id	id of existing contact
contactname	name for the contact
number	phone number for the contact
public	<i>(optional parameter)</i> 0 = private group, 1 = public group
responsetype	<i>(optional parameter)</i> simple = format response as simple object with one result field (default), extended = format response as extended JSON object

EXAMPLES:

```
{ "method": "phonebook.contact_update",
  "params": { "access_token": "0005gOjCOlMH8F2x", "contact_id": "4", "contactname": "johnlord", "number": "123456789", "public": "1" } }
```

RESPONSE:

Response: {"result": "OK"}

Response (when wrong logindata): {"result": "Invalid login or password"}

Response (when wrong access token): {"result": "Invalid access token"}

Response (when wrong parameters):

```
{"result": "Wrong or missing >>contactname<< parameter"}
```

```
{"result": "Wrong or missing >>contact_id<< parameter"}
```

```
{"result": "Wrong or missing >>number<< parameter"}
```

Response (when contact_id is wrong): {"result": "Contact with the given id does not exists"}

RESPONSE (EXTENDED):

Response: {"result": {"status": "ok"}}

Response (when wrong logindata):

```
{"result": { "error_text": "Invalid login or password", "status": "error" } }
```

Response (when wrong access token):

```
{"result": { "error_text": "Invalid access token", "status": "error" } }
```

Response (when wrong parameters):

```
{"result": { "error_text": "Wrong or missing >>contactname<< parameter", "status": "error" } }
```

```
{"result": { "error_text": "Wrong or missing >>contact_id<< parameter", "status": "error" } }
```

```
{"result": { "error_text": "Wrong or missing >>number<< parameter", "status": "error" } }
```

Response (when contact_id is wrong):

```
{"result": {"error_text": "Contact with the given id does not exists", "status": "error"}}
```

41. Phonebook contact delete: HTTP GET method

HTTP GET METHOD:

`https://url-of-smseagle/http_api/contact_delete`

Parameter	Description
access_token	authentication access token (see details in point API Authentication)
login	your user to login to SMSEagle (see details in point API Authentication)
pass	your password to login to SMSEagle
contact_id	id of existing contact
contactname	name of existing contact
responsetype	<i>(optional parameter)</i> text = format response as text (default), xml = format response as XML object

EXAMPLES:

```
https://url-of-smseagle/http_api/contact_delete?  
access_token=0005gOjCOlMH8F2x&contact_id=4&contactname=johnlord
```

RESPONSE:

Response: **OK**

Response (when wrong logindata): **Invalid login or password**

Response (when wrong access token): **Invalid access token**

Response (when wrong parameters):

Wrong or missing >>contactname<< parameter

Wrong or missing >>contact_id<< parameter

Response (when contact_id is wrong): **Contact with the given id and name does not exists**

RESPONSE (XML):

Response:

```
<xml>  
  <status>ok</status>  
</xml>
```

Response (when wrong logindata):

```
<xml>  
  <error_text>Invalid login or password</error_text>  
  <status>error</status>
```

```
</xml>
```

Response (when wrong access token):

```
<xml>
  <error_text>Invalid Access token</error_text>
  <status>error</status>
</xml>
```

Response (when wrong parameters):

```
<xml>
  <error_text>Wrong or missing >>contactname<< parameter</error_text>
  <status>error</status>
</xml>
```

```
<xml>
  <error_text>Wrong or missing >>contact_id<< parameter</error_text>
  <status>error</status>
</xml>
```

Response (when contact_id is wrong):

```
<xml>
  <error_text>Contact with the given id and name does not exists </error_text>
  <status>error</status>
</xml>
```

42. Phonebook contact delete: JSONRPC method

HTTP POST METHOD:

<https://url-of-smseagle/jsonrpc/sms>

Parameter	Description
access_token	authentication access token (see details in point API Authentication)
login	your user to login to SMSEagle (see details in point API Authentication)
pass	your password to login to SMSEagle
contact_id	id of existing contact
contactname	name of existing contact
responsetype	<i>(optional parameter)</i> simple = format response as simple object with one result field (default), extended = format response as extended JSON object

EXAMPLES:

```
{"method": "phonebook.contact_delete",
"params": {"access_token": "0005gOjCO1MH8F2x", "contact_id": "4", "contactname": "johnlord"}}
```

RESPONSE:

Response: {"result": "OK"}

Response (when wrong logindata): {"result": "Invalid login or password"}

Response (when wrong access token): {"result": "Invalid access token"}

Response (when wrong parameters):

```
{"result": "Wrong or missing >>contactname<< parameter"}
```

```
{"result": "Wrong or missing >>contact_id<< parameter"}
```

Response (when contact_id is wrong): {"result": "Contact with the given id and name does not exists"}

RESPONSE (EXTENDED):

Response: {"result":{"status":"ok"}}

Response (when wrong logindata):

```
{"result": {"error_text":"Invalid login or password","status":"error"}}
```

Response (when wrong access token):

```
{"result": {"error_text":"Invalid access token","status":"error"}}
```

Response (when wrong parameters):

```
{"result": {"error_text":"Wrong or missing >>contactname<< parameter","status":"error"}}
```

```
{"result": {"error_text":"Wrong or missing >>contact_id<< parameter","status":"error"}}
```

Response (when contact_id is wrong):

```
{"result": {"error_text":"Contact with the given id and name does not exists","status":"error"}}
```

43. Call with termination: HTTP GET method

HTTP GET METHOD:

https://url-of-smseagle/http_api/call_with_termination

Parameter	Description
access_token	authentication access token (see details in point API Authentication)
login	your user to login to SMSEagle (see details in point API Authentication)
pass	your password to login to SMSEagle
to	phone number to call
duration	connection duration (in seconds)
modem_no	<i>(optional parameter)</i> modem number (only for multimodem devices)
responsetype	<i>(optional parameter)</i> text = format response as text (default), xml = format response as XML object

EXAMPLES:

`https://url-of-smseagle/http_api/call_with_termination?
access_token=0005gOjCO1MH8F2x&to=123456789&duration=5`

RESPONSE:

Response: **OK**

Response (when wrong logindata): **Invalid login or password**

Response (when wrong access token): **Invalid access token**

Response (when modem doesn't support voice calls): **This modem doesn't support voice calls**

Response (when wrong parameters):

Wrong or missing >>to<< parameter

Wrong or missing >>duration<< parameter

Response (when modem_no is wrong): **Modem not recognized**

RESPONSE (XML):

Response:

```
<xml>  
  <status>ok</status>  
</xml>
```

Response (when wrong logindata):

```
<xml>  
  <error_text>Invalid login or password</error_text>  
  <status>error</status>  
</xml>
```

Response (when wrong access token):

```
<xml>  
  <error_text>Invalid Access token</error_text>  
  <status>error</status>  
</xml>
```

Response (when wrong parameters):

```
<xml>  
  <error_text>Wrong or missing >>duration<< parameter</error_text>  
  <status>error</status>  
</xml>
```

Response (when modem doesn't support voice calls):

```
<xml>  
  <error_text>This modem doesn't support voice calls</error_text>  
  <status>error</status>  
</xml>
```

Response (when modem_no is wrong):

```
<xml>
  <error_text> Modem not recognized </error_text>
  <status>error</status>
</xml>
```

Important notice: this method is available only for devices with [voice modem](#)

44. Call with termination: JSONRPC method

HTTP POST METHOD:

<https://url-of-smseagle/jsonrpc/sms>

Parameter	Description
access_token	authentication access token (see details in point API Authentication)
login	your user to login to SMSEagle (see details in point API Authentication)
pass	your password to login to SMSEagle
to	phone numer to call
duration	connection duration (in seconds)
modem_no	<i>(optional parameter)</i> calling modem number (only for multimodem devices)
responsetype	<i>(optional parameter)</i> simple = format response as simple object with one result field (default), extended = format response as extended JSON object

EXAMPLES:

```
{"method":"phone.call_with_termination",
"params":{"access_token":"0005gOjCOlMH8F2x","to":"123456789",
"duration":"5"}}
```

RESPONSE:

Response: {"result": "OK"}

Response (when wrong logindata): {"result": "Invalid login or password"}

Response (when wrong access token): {"result": "Invalid access token"}

Response (when modem doesn't support voice calls): {"result": "This modem doesn't support voice calls"}

Response (when wrong parameters):

```
{"result": "Wrong or missing >>to<< parameter"}
```

```
{"result": "Wrong or missing >>duration<< parameter"}
```

Response (when modem_no is wrong): {"result": "Modem not recognized"}

RESPONSE (EXTENDED):

```
Response: {"result":{"status":"ok"}}
```

Response (when wrong logindata):

```
{"result": {"error_text": "Invalid login or password", "status": "error"}}
```

Response (when wrong access token):

```
{"result": {"error_text": "Invalid access token", "status": "error"}}
```

Response (when modem doesn't support voice calls):

```
{"result": {"error_text": "This modem doesn't support voice calls", "status": "error"}}
```

Response (when wrong parameters):

```
{"result": {"error_text": "Wrong or missing >>to<< parameter", "status": "error"}}
```

```
{"result": {"error_text": "Wrong or missing >>duration<< parameter", "status": "error"}}
```

Response (when modem_no is wrong):

```
{"result": {"error_text": "Modem not recognized", "status": "error"}}
```

Important notice: this method is available only for devices with [voice modem](#)

45. Phonebook shift create: HTTP GET method

HTTP GET METHOD:

https://url-of-smseagle/http_api/shift_create

Parameter	Description
access_token	authentication access token (see details in point API Authentication)
login	your user to login to SMSEagle (see details in point API Authentication)
pass	your password to login to SMSEagle
name	name for the created shift
enabled	0 = disabled, 1 = enabled
(mon-sun)_from	<i>shift start hour for each day of week</i>
(mon-sun)_to	<i>shift end hour for each day of week</i>
responsetype	<i>(optional parameter)</i> text = format response as text (default), xml = format response as XML object

EXAMPLES:

```
https://url-of-smseagle/http_api/shift_create?  
access_token=0005gOjCO1MH8F2x&name=myshift&mon_from=08:00&mon_to=16:00&wed_  
from=09:00&wed_to=20:00&enabled=1
```

RESPONSE:

Response: **OK; ID=[ID of created shift]**

Sample response: OK; ID=5

Response (when wrong logindata): **Invalid login or password**

Response (when wrong access token): **Invalid access token**

Response (when wrong parameters): **Wrong or missing >>name<< parameter**

RESPONSE (XML):

Response:

```
<xml>
  <shift_id>[ID of created shift]</shift_id>
  <status>ok</status>
</xml>
```

Sample response:

```
<xml>
  <shift_id>5</shift_id>
  <status>ok</status>
</xml>
```

Response (when wrong logindata):

```
<xml>
  <error_text>Invalid login or password</error_text>
  <status>error</status>
</xml>
```

Response (when wrong access token):

```
<xml>
  <error_text>Invalid Access token</error_text>
  <status>error</status>
</xml>
```

Response (when wrong parameters):

```
<xml>
  <error_text>Wrong or missing >>name<< parameter</error_text>
  <status>error</status>
</xml>
```

46. Phonebook shift create: JSONRPC method

HTTP POST METHOD:

<https://url-of-smseagle/jsonrpc/sms>

Parameter	Description
access_token	authentication access token (see details in point API Authentication)
login	your user to login to SMSEagle (see details in point API Authentication)
pass	your password to login to SMSEagle

name	name for the created shift
enabled	0 = disabled, 1 = enabled
(mon-sun)_from	<i>shift start hour for each day of week</i>
(mon-sun)_to	<i>shift end hour for each day of week</i>
responsetype	<i>(optional parameter)</i> simple = format response as simple object with one result field (default), extended = format response as extended JSON object

EXAMPLES:

```
{ "method": "phonebook.shift_create",
  "params": { "access_token": "0005gOjCO1MH8F2x", "name": "myshift", "mon_from": "08:00", "mon_to": "16:00", "wed_from": "09:00", "wed_to": "20:00", "enabled": "1" } }
```

RESPONSE:

Response: {"result": "OK; ID=[ID of created shift]"}

Sample response: {"result": "OK; ID=5"}

Response (when wrong logindata): {"result": "Invalid login or password"}

Response (when wrong access token): {"result": "Invalid access token"}

Response (when wrong parameters): {"result": "Wrong or missing >>name<< parameter"}

RESPONSE (EXTENDED):

Response:

```
{ "result": { "shift_id": "[ID of created shift]", "status": "ok" } }
```

Sample response: {"result": { "shift_id": "748", "status": "ok" } }

Response (when wrong logindata):

```
{ "result": { "error_text": "Invalid login or password", "status": "error" } }
```

Response (when wrong access token):

```
{ "result": { "error_text": "Invalid access token", "status": "error" } }
```

Response (when wrong parameters):

```
{ "result": { "error_text": "Wrong or missing >>name<< parameter", "status": "error" } }
```

47. Phonebook shift read: HTTP GET method

HTTP GET METHOD:

https://url-of-smseagle/http_api/shift_read

Parameter	Description
access_token	authentication access token (see details in point API Authentication)
login	your user to login to SMSEagle (see details in point API Authentication)

pass	your password to login to SMSEagle
name	<i>(optional parameter)</i> shift name
enabled	<i>(optional parameter)</i> 0 = disabled, 1 = enabled
shift_id	<i>(optional parameter)</i> shift id
responsetype	<i>(optional parameter)</i> text = format response as text (default), xml = format response as XML object

EXAMPLES:

https://url-of-smseagle/http_api/shift_read?
access_token=0005gOjCO1MH8F2x&name=myshift

RESPONSE:

Sample response: [link](#)

Response (when no data): **No data to display**

Response (when wrong logindata): **Invalid login or password**

Response (when wrong access token): **Invalid access token**

Response (when wrong parameters):

Wrong >>shift_id<< parameter

RESPONSE (XML):

Sample response:

```
<xml>
<shifts>
  <shift>
    <id_shift>62</id_shift>
    <name>myshift</name>
    <mon_from>08:00</mon_from>
    <mon_to>16:00</mon_to>
    <tue_from/>
    <tue_to/>
    <wed_from>09:00</wed_from>
    <wed_to>20:00</wed_to>
    <thu_from/>
    <thu_to/>
    <fri_from/>
    <fri_to/>
    <sat_from/>
    <sat_to/>
    <sun_from/>
    <sun_to/>
    <enabled>true</enabled>
  </shift>
</shifts>
```

```
<status>ok</status>
</xml>
```

Response (when no data):

```
<xml>
  <error_text>No data to display</error_text>
  <status>error</status>
</xml>
```

Response (when wrong logindata):

```
<xml>
  <error_text>Invalid login or password</error_text>
  <status>error</status>
</xml>
```

Response (when wrong access token):

```
<xml>
  <error_text>Invalid Access token</error_text>
  <status>error</status>
</xml>
```

Response (when wrong parameters):

```
<xml>
  <error_text> Wrong >>id<< parameter</error_text>
  <status>error</status>
</xml>
```

Response (when wrong parameters):

```
<xml>
  <error_text> Wrong >>enabled<< parameter</error_text>
  <status>error</status>
</xml>
```

48. Phonebook shift read: JSONRPC method

HTTP POST METHOD:

<https://url-of-smseagle/jsonrpc/sms>

Parameter	Description
access_token	authentication access token (see details in point API Authentication)
login	your user to login to SMSEagle (see details in point API Authentication)
pass	your password to login to SMSEagle
name	<i>(optional parameter)</i> shift name
enabled	<i>(optional parameter)</i> 0 = disabled, 1 = enabled
shift_id	<i>(optional parameter)</i> shift id

responsetype	(optional parameter) simple = format response as simple object with one result field (default), extended = format response as extended JSON object
--------------	--

EXAMPLES:

```
{ "method": "phonebook.shift_read",
  "params": { "access_token": "0005gOjCO1MH8F2x", "name": "myshift" } }
```

RESPONSE:

Sample response:

```
{
  "result": [
    {
      "id_shift": "62",
      "name": "myshift",
      "mon_from": "08:00",
      "mon_to": "16:00",
      "tue_from": null,
      "tue_to": null,
      "wed_from": "09:00",
      "wed_to": "20:00",
      "thu_from": null,
      "thu_to": null,
      "fri_from": null,
      "fri_to": null,
      "sat_from": null,
      "sat_to": null,
      "sun_from": null,
      "sun_to": null,
      "enabled": "true"
    }
  ]
}
```

Response (when no data): {"result": "No data to display"}

Response (when wrong login data): {"result": "Invalid login or password"}

Response (when wrong access token): {"result": "Invalid access token"}

Response (when wrong parameters):

```
{"result": "Wrong >>enabled<< parameter"}
{"result": "Wrong >>shift_id<< parameter"}
```

RESPONSE (EXTENDED):

Sample response:

```
{
  "result": {
    "shifts": [
      {
        "id_shift": "62",
        "name": "myshift",
        "mon_from": "08:00",
        "mon_to": "16:00",
        "tue_from": null,

```

```

        "tue_to": null,
        "wed_from": "09:00",
        "wed_to": "20:00",
        "thu_from": null,
        "thu_to": null,
        "fri_from": null,
        "fri_to": null,
        "sat_from": null,
        "sat_to": null,
        "sun_from": null,
        "sun_to": null,
        "enabled": "false"
    }
],
    "status": "ok"
}
}

```

Response (when no data):

```

{"result": {"error_text": " No data to display", "status": "error"}}

```

Response (when wrong logindata):

```

{"result": {"error_text": "Invalid login or password", "status": "error"}}

```

Response (when wrong access token):

```

{"result": {"error_text": "Invalid access token", "status": "error"}}

```

Response (when wrong parameters):

```

{"result": {"error_text": " Wrong >> enabled<< parameter ", "status": "error"}}

```

```

{"result": {"error_text": " Wrong >> shift_id<< parameter
", "status": "error"}}

```

49. Phonebook shift update: HTTP GET method

HTTP GET METHOD:

https://url-of-smseagle/http_api/shift_update

Parameter	Description
access_token	authentication access token (see details in point API Authentication)
login	your user to login to SMSEagle (see details in point API Authentication)
pass	your password to login to SMSEagle
shift_id	id of existing shift
name	name for the shift
enabled	0 = disabled, 1 = enabled
responsetype	<i>(optional parameter)</i> text = format response as text (default), xml = format response as XML object

EXAMPLES:

`https://url-of-smseagle/http_api/shift_update?
access_token=0005gOjCO1MH8F2x&shift_id=24&name=updatedshift&enabled=1`

RESPONSE:

Response: **OK**

Response (when wrong logindata): **Invalid login or password**

Response (when wrong access token): **Invalid access token**

Response (when wrong parameters):

Wrong or missing >>name<< parameter

Wrong or missing >>shift_id<< parameter

Response (when shift_id is wrong): **Shift with the given id does not exists**

RESPONSE (XML):

Response:

```
<xml>  
  <status>ok</status>  
</xml>
```

Response (when wrong logindata):

```
<xml>  
  <error_text>Invalid login or password</error_text>  
  <status>error</status>  
</xml>
```

Response (when wrong access token):

```
<xml>  
  <error_text>Invalid Access token</error_text>  
  <status>error</status>  
</xml>
```

Response (when wrong parameters):

```
<xml>  
  <error_text>Wrong or missing >>name<< parameter</error_text>  
  <status>error</status>  
</xml>
```

```
<xml>  
  <error_text>Wrong or missing >>shift_id<< parameter</error_text>  
  <status>error</status>  
</xml>
```

Response (when shift_id is wrong):

```
<xml>  
  <error_text>Shift with given id does not exists</error_text>  
  <status>error</status>
```

</xml>

50. Phonebook shift update: JSONRPC method

HTTP POST METHOD:

https://url-of-smseagle/jsonrpc/sms

Parameter	Description
access_token	authentication access token (see details in point API Authentication)
login	your user to login to SMSEagle (see details in point API Authentication)
pass	your password to login to SMSEagle
shift_id	id of existing shift
name	name for the shift
enabled	0 = disabled, 1 = enabled
responsetype	<i>(optional parameter)</i> simple = format response as simple object with one result field (default), extended = format response as extended JSON object

EXAMPLES:

```
{ "method": "phonebook.shift_update",  
  "params": { "access_token": "0005gOjCO1MH8F2x", "shift_id": "24", "name": "updated  
shift", "enabled": "1" } }
```

RESPONSE:

Response: {"result": "OK"}

Response (when wrong logindata): {"result": "Invalid login or password"}

Response (when wrong access token): {"result": "Invalid access token"}

Response (when wrong parameters):

```
{"result": "Wrong or missing >>name<< parameter"}
```

```
{"result": "Wrong or missing >>shift_id<< parameter"}
```

Response (when shift_id is wrong): {"result": "Shift with the given id does not exists"}

RESPONSE (EXTENDED):

Response: {"result": {"status": "ok"}}

Response (when wrong logindata):

```
{"result": { "error_text": "Invalid login or password", "status": "error" } }
```

Response (when wrong access token):

```
{"result": { "error_text": "Invalid access token", "status": "error" } }
```

Response (when wrong parameters):

```
{"result": { "error_text": "Wrong or missing >>name<<  
parameter", "status": "error" } }
```



```
{"result": {"error_text": "Wrong or missing >>shift_id<< parameter", "status": "error"}}
```

Response (when shift_id is wrong):

```
{"result": {"error_text": "Shift with the given id does not exists", "status": "error"}}
```

51. Phonebook shift delete: HTTP GET method

HTTP GET METHOD:

https://url-of-smseagle/http_api/shift_delete

Parameter	Description
access_token	authentication access token (see details in point API Authentication)
login	your user to login to SMSEagle (see details in point API Authentication)
pass	your password to login to SMSEagle
shift_id	id of existing shift
responsetype	<i>(optional parameter)</i> text = format response as text (default), xml = format response as XML object

EXAMPLES:

https://url-of-smseagle/http_api/shift_delete?access_token=0005gOjCOlMH8F2x&shift_id=24

RESPONSE:

Response: **OK**

Response (when wrong logindata): **Invalid login or password**

Response (when wrong access token): **Invalid access token**

Response (when wrong parameters):

Wrong or missing >>shift_id<< parameter

Response (when shift_id is wrong): **Shift with the given id does not exist**

RESPONSE (XML):

Response:

```
<xml>
  <status>ok</status>
</xml>
```

Response (when wrong logindata):

```
<xml>
  <error_text>Invalid login or password</error_text>
  <status>error</status>
```

```
</xml>
```

Response (when wrong access token):

```
<xml>
  <error_text>Invalid Access token</error_text>
  <status>error</status>
</xml>
```

Response (when wrong parameters):

```
<xml>
  <error_text>Wrong or missing >>shift_id<< parameter</error_text>
  <status>error</status>
</xml>
```

Response (when shift_id is wrong):

```
<xml>
  <error_text>Shift with the given id does not exists</error_text>
  <status>error</status>
</xml>
```

52. Phonebook shift delete: JSONRPC method

HTTP POST METHOD:

<https://url-of-smseagle/jsonrpc/sms>

Parameter	Description
access_token	authentication access token (see details in point API Authentication)
login	your user to login to SMSEagle (see details in point API Authentication)
pass	your password to login to SMSEagle
shift_id	id of existing shift
responsetype	<i>(optional parameter)</i> simple = format response as simple object with one result field (default), extended = format response as extended JSON object

EXAMPLES:

```
{"method": "phonebook.shift_delete",
"params": {"access_token": "0005gOjCO1MH8F2x", "shift_id": "24"}}
```

RESPONSE:

Response: {"result": "OK"}

Response (when wrong logindata): {"result": "Invalid login or password"}

Response (when wrong access token): {"result": "Invalid access token"}

Response (when wrong parameters):

```
{"result": "Wrong or missing >>shift_id<< parameter"}
```

Response (when shift_id is wrong): {"result": "Shift with the given id does not exist"}

RESPONSE (EXTENDED):

Response: {"result":{"status":"ok"}}

Response (when wrong logindata):

```
{"result": {"error_text":"Invalid login or password","status":"error"}}
```

Response (when wrong access token):

```
{"result": {"error_text":"Invalid access token","status":"error"}}
```

Response (when wrong parameters):

```
{"result": {"error_text":"Wrong or missing >>shift_id<< parameter","status":"error"}}
```

Response (when shift_id is wrong):

```
{"result": {"error_text":"Shift with the given id does not exists","status":"error"}}
```

53. Phonebook shift add contact: HTTP GET method

HTTP GET METHOD:

https://url-of-smseagle/http_api/shift_addcontact

Parameter	Description
access_token	authentication access token (see details in point API Authentication)
login	your user to login to SMSEagle (see details in point API Authentication)
pass	your password to login to SMSEagle
shift_id	id of existing shift (or id's separated with comma)
contact_id	id of contact. The contact will be added to the shift
responsetype	<i>(optional parameter)</i> text = format response as text (default), xml = format response as XML object

EXAMPLES:

```
https://url-of-smseagle/http_api/shift_addcontact?  
access_token=0005gOjCO1MH8F2x&shift_id=2&contact_id=1
```

RESPONSE:

Response: **OK**

Response (when wrong logindata): **Invalid login or password**

Response (when wrong access token): **Invalid access token**

Response (when wrong parameters):

Wrong or missing >>shift_id<< parameter

Wrong or missing >>contact_id<< parameter

Response (when id is wrong):

Shift with the given id does not exists

Contact with the given id does not exists

RESPONSE (XML):

Response:

```
<xml>
  <status>ok</status>
</xml>
```

Response (when wrong logindata):

```
<xml>
  <error_text>Invalid login or password</error_text>
  <status>error</status>
</xml>
```

Response (when wrong access token):

```
<xml>
  <error_text>Invalid Access token</error_text>
  <status>error</status>
</xml>
```

Response (when wrong parameters):

```
<xml>
  <error_text>Wrong or missing >>shift_id<< parameter</error_text>
  <status>error</status>
</xml>
```

```
<xml>
  <error_text>Wrong or missing >>contact_id<< parameter</error_text>
  <status>error</status>
</xml>
```

Response (when id is wrong):

```
<xml>
  <error_text>Shift with the given id does not exists</error_text>
  <status>error</status>
</xml>
```

```
<xml>
  <error_text>Contact with the given id does not exists</error_text>
  <status>error</status>
</xml>
```

54. Phonebook shift add contact: JSONRPC method

HTTP POST METHOD:

<https://url-of-smseagle/jsonrpc/sms>

Parameter	Description
access_token	authentication access token (see details in point API Authentication)
login	your user to login to SMSEagle (see details in point API Authentication)
pass	your password to login to SMSEagle
shift_id	id of existing shift (or id's separated with comma)
contact_id	id of contact. The contact will be added to the shift
responsetype	<i>(optional parameter)</i> simple = format response as simple object with one result field (default), extended = format response as extended JSON object

EXAMPLES:

```
{"method": "phonebook.shift_addcontact",  
"params": {"access_token": "0005gOjCOlMH8F2x", "shift_id": "24", "contact_id": "1"  
}}
```

RESPONSE:

Response: {"result": "OK"}

Response (when wrong logindata): {"result": "Invalid login or password"}

Response (when wrong access token): {"result": "Invalid access token"}

Response (when wrong parameters):

```
{"result": "Wrong or missing >>shift_id<< parameter"}
```

```
{"result": "Wrong or missing >>contact_id<< parameter"}
```

Response (when id is wrong):

```
{"result": "Shift with the given id does not exists"}
```

```
{"result": "Contact with the given id does not exists"}
```

RESPONSE (EXTENDED):

Response: {"result":{"status":"ok"}}

Response (when wrong logindata):

```
{"result": {"error_text": "Invalid login or password", "status": "error"}}
```

Response (when wrong access token):

```
{"result": {"error_text": "Invalid access token", "status": "error"}}
```

Response (when wrong parameters):

```
{"result": {"error_text": "Wrong or missing >>shift_id<<  
parameter", "status": "error"}}
```

```
{"result": {"error_text": "Wrong or missing >>contact_id<<  
parameter", "status": "error"}}
```

Response (when id is wrong):

```
{"result": {"error_text": "Shift with the given id does not exists", "status": "error"}}
```

```
{"result": {"error_text": "Contact with the given id does not exists", "status": "error"}}
```

55. Phonebook shift remove contact: HTTP GET method

HTTP GET METHOD:

https://url-of-smseagle/http_api/shift_removecontact

Parameter	Description
access_token	authentication access token (see details in point API Authentication)
login	your user to login to SMSEagle (see details in point API Authentication)
pass	your password to login to SMSEagle
shift_id	id of existing shift (or id's separated with comma)
contact_id	id of contact. The contact will be added to the shift
responsetype	<i>(optional parameter)</i> text = format response as text (default), xml = format response as XML object

EXAMPLES:

```
https://url-of-smseagle/http_api/shift_removecontact?  
access_token=0005gOjCO1MH8F2x&shift_id=24&contact_id=1
```

RESPONSE:

Response: **OK**

Response (when wrong logindata): **Invalid login or password**

Response (when wrong access token): **Invalid access token**

Response (when wrong parameters):

Wrong or missing >>shift_id<< parameter

Wrong or missing >>contact_id<< parameter

Response (when id is wrong):

Shift with the given id does not exists

Contact with the given id does not exists

RESPONSE (XML):

Response:

```
<xml>  
  <status>ok</status>  
</xml>
```

Response (when wrong logindata):

```
<xml>
  <error_text>Invalid login or password</error_text>
  <status>error</status>
</xml>
```

Response (when wrong access token):

```
<xml>
  <error_text>Invalid Access token</error_text>
  <status>error</status>
</xml>
```

Response (when wrong parameters):

```
<xml>
  <error_text>Wrong or missing >>shift_id<< parameter</error_text>
  <status>error</status>
</xml>
```

```
<xml>
  <error_text>Wrong or missing >>contact_id<< parameter</error_text>
  <status>error</status>
</xml>
```

Response (when id is wrong):

```
<xml>
  <error_text>Shift with the given id does not exists</error_text>
  <status>error</status>
</xml>
```

```
<xml>
  <error_text>Contact with the given id does not exists</error_text>
  <status>error</status>
</xml>
```

56. Phonebook shift remove contact: JSONRPC method

HTTP POST METHOD:

<https://url-of-smseagle/jsonrpc/sms>

Parameter	Description
access_token	authentication access token (see details in point API Authentication)
login	your user to login to SMSEagle (see details in point API Authentication)
pass	your password to login to SMSEagle
shift_id	id of existing shift (or id's separated with comma)

contact_id	id of contact. The contact will be added to the shift
responsetype	<i>(optional parameter)</i> simple = format response as simple object with one result field (default), extended = format response as extended JSON object

EXAMPLES:

```
{ "method": "phonebook.shift_removecontact",
  "params": { "access_token": "0005gOjCOlMH8F2x", "shift_id": "24", "contact_id": "1"
}
```

RESPONSE:

Response: {"result": "OK"}

Response (when wrong logindata): {"result": "Invalid login or password"}

Response (when wrong access token): {"result": "Invalid access token"}

Response (when wrong parameters):

```
{ "result": "Wrong or missing >>shift_id<< parameter"
  "result": "Wrong or missing >>contact_id<< parameter" }
```

Response (when id is wrong):

```
{ "result": "Shift with the given id does not exists"
  "result": "Contact with the given id does not exists" }
```

RESPONSE (EXTENDED):

Response: {"result": {"status": "ok"}}

Response (when wrong logindata):

```
{ "result": { "error_text": "Invalid login or password", "status": "error" } }
```

Response (when wrong access token):

```
{ "result": { "error_text": "Invalid access token", "status": "error" } }
```

Response (when wrong parameters):

```
{ "result": { "error_text": "Wrong or missing >>shift_id<<
  parameter", "status": "error" } }
```

```
{ "result": { "error_text": "Wrong or missing >>contact_id<<
  parameter", "status": "error" } }
```

Response (when id is wrong):

```
{ "result": { "error_text": "Shift with the given id does not
  exists", "status": "error" } }
```

```
{ "result": { "error_text": "Contact with the given id does not
  exists", "status": "error" } }
```

57. Get modem state: HTTP GET method

HTTP GET METHOD:

https://url-of-smseagle/http_api/get_modem_state

Parameter	Description
-----------	-------------

access_token	authentication access token (see details in point API Authentication)
login	your user to login to SMSEagle (see details in point API Authentication)
pass	your password to login to SMSEagle
modem_no	<i>(optional parameter)</i> modem number to be queried (default = 1). Used only in multimodem devices
responsetype	<i>(optional parameter)</i> text = format response as text (default), xml = format response as XML object

EXAMPLES:

```
https://url-of-smseagle/http_api/get_modem_state?
access_token=0005gOjCO1MH8F2x&modem_no=1
```

RESPONSE:

Response: **enabled / disabled**

Sample response: enabled

Response (when wrong logindata): **Invalid login or password**

Response (when wrong access token): **Invalid access token**

Response (when modem doesn't exist): **Wrong modem number**

RESPONSE (XML):

Response:

```
<xml>
  <modem_status>
    enabled / disabled
  </modem_status>
  <status>
    ok
  </status>
</xml>
```

Sample response:

```
<xml>
  <modem_status>
    enabled
  </modem_status>
  <status>
    ok
  </status>
</xml>
```

Response (when wrong logindata):

```
<xml>
  <error_text>Invalid login or password</error_text>
  <status>error</status>
</xml>
```

Response (when wrong access token):

```
<xml>
  <error_text>Invalid Access token</error_text>
  <status>error</status>
</xml>
```

Response (when modem doesn't exist):

```
<xml>
  <error_text> Wrong modem number</error_text>
  <status>error</status>
</xml>
```

58. Get modem state: JSONRPC method

HTTP POST METHOD:

`https://url-of-smseagle/jsonrpc/sms`

Parameter	Description
access_token	authentication access token (see details in point API Authentication)
login	your user to login to SMSEagle (see details in point API Authentication)
pass	your password to login to SMSEagle
modem_no	<i>(optional parameter)</i> modem number to be queried (default = 1). Used only in multimodem devices
responsetype	<i>(optional parameter)</i> simple = format response as simple object with one result field (default), extended = format response as extended JSON object

BODY:

```
{"method": "sms.get_modem_state",
"params": {"access_token": "0005gOjCO1MH8F2x"}}
```

RESPONSE:

```
{"result": enabled / disabled }
```

Sample response: {"result": "enabled"}

Response (when wrong logindata): {"result": "Invalid login or password"}

Response (when wrong access token): {"result": "Invalid access token"}

Response (when modem doesn't exist): {"result": "Wrong modem number"}

RESPONSE (EXTENDED):

Response:

```
{"result": {"modem_status": enabled / disabled, "status": "ok"}}
```

Sample response: {"result": {"modem_status": "Wrong modem

```
number", "status": "ok"}}
```

Response (when wrong logindata):

```
{"result": {"error_text": "Invalid login or password", "status": "error"}}
```

Response (when wrong access token):

```
{"result": {"error_text": "Invalid access token", "status": "error"}}
```

Response (when modem doesn't exist):

```
{"result": {"error_text": "Wrong modem number", "status": "error"}}
```

59. Set modem state: HTTP GET method

HTTP GET METHOD:

https://url-of-smseagle/http_api/set_modem_state

Parameter	Description
access_token	authentication access token (see details in point API Authentication)
login	your user to login to SMSEagle (see details in point API Authentication)
pass	your password to login to SMSEagle
modem_no	<i>(optional parameter)</i> modem number for status change (default = 1). Used only in multimodem devices
status	<i>enabled / disabled</i>
responsetype	<i>(optional parameter)</i> text = format response as text (default), xml = format response as XML object

EXAMPLES:

```
https://url-of-smseagle/http_api/set_modem_state?  
access_token=0005gOjCO1MH8F2x&modem_no=1&status=enabled
```

RESPONSE:

Response: **OK**

Response (when wrong logindata): **Invalid login or password**

Response (when wrong access token): **Invalid access token**

Response (when modem doesn't exist): **Wrong modem number**

Response (when wrong modem state): **Wrong modem state**

RESPONSE (XML):

Response:

```
<xml>  
<status>  
  ok  
</status>  
</xml>
```

Response (when wrong logindata):

```
<xml>
  <error_text>Invalid login or password</error_text>
  <status>error</status>
</xml>
```

Response (when wrong access token):

```
<xml>
  <error_text>Invalid Access token</error_text>
  <status>error</status>
</xml>
```

Response (when modem doesn't exist):

```
<xml>
  <error_text> Wrong modem number</error_text>
  <status>error</status>
</xml>
```

Response (when wrong modem state):

```
<xml>
  <error_text>Wrong modem state</error_text>
  <status>error</status>
</xml>
```

60. Set modem state: JSONRPC method

HTTP POST METHOD:

<https://url-of-smseagle/jsonrpc/sms>

Parameter	Description
access_token	authentication access token (see details in point API Authentication)
login	your user to login to SMSEagle (see details in point API Authentication)
pass	your password to login to SMSEagle
modem_no	<i>(optional parameter)</i> modem number for status change (default = 1). Used only in multimodem devices
status	<i>enabled / disabled</i>
responsetype	<i>(optional parameter)</i> simple = format response as simple object with one result field (default), extended = format response as extended JSON object

BODY:

```
{ "method": "sms.set_modem_state",
  "params": { "access_token": "0005gOjCO1MH8F2x", "status": "enabled" } }
```

RESPONSE:

```
{"result": enabled / disabled }
```

Sample response: {"result": "enabled"}

Response (when wrong logindata): {"result": "Invalid login or password"}

Response (when wrong access token): {"result": "Invalid access token"}

Response (when modem doesn't exist): {"result": "Wrong modem number"}

Response (when wrong modem state): {"result": "Wrong modem state"}

RESPONSE (EXTENDED):

Response:

```
{"result":{"modem_status": enabled / disabled,"status":"ok"}}
```

Sample response: {"result": {"modem_status": "Wrong modem number", "status": "ok"}}

Response (when wrong logindata):

```
{"result": {"error_text": "Invalid login or password", "status": "error"}}
```

Response (when wrong access token):

```
{"result": {"error_text": "Invalid access token", "status": "error"}}
```

Response (when modem doesn't exist):

```
{"result": {"error_text": "Wrong modem number", "status": "error"}}
```

Response (when wrong modem state):

```
{"result": {"error_text": "Wrong modem state", "status": "error"}}
```

61. User ID read: HTTP GET method

HTTP GET METHOD:

https://url-of-smseagle/http_api/userid_read

Parameter	Description
access_token	authentication access token (see details in point API Authentication)
login	your user to login to SMSEagle (see details in point API Authentication)
pass	your password to login to SMSEagle
username	<i>username to be queried</i>
responsetype	<i>(optional parameter)</i> text = format response as text (default), xml = format response as XML object

EXAMPLES:

```
https://url-of-smseagle/http_api/userid_read?  
access_token=0005gOjCOlMH8F2x&username=myuser
```

RESPONSE:

Response: **User ID**

Sample response: 24

Response (when username parameter is missing): **Missing >>username<< parameter**

Response (when user doesn't exist): **Wrong >>username<< parameter**

RESPONSE (XML):

Response:

```
<xml>
  <status>
    ok
  </status>
</xml>
```

Response (when username parameter is missing):

```
<xml>
  <error_text>Missing >>username<< parameter</error_text>
  <status>error</status>
</xml>
```

Response (when user doesn't exist):

```
<xml>
  <error_text>Wrong >>username<< parameter</error_text>
  <status>error</status>
</xml>
```

62. User ID read: JSONRPC method

HTTP POST METHOD:

<https://url-of-smseagle/jsonrpc/sms>

Parameter	Description
access_token	authentication access token (see details in point API Authentication)
login	your user to login to SMSEagle (see details in point API Authentication)
pass	your password to login to SMSEagle
username	<i>username to be queried</i>
responsetype	<i>(optional parameter)</i> simple = format response as simple object with one result field (default), extended = format response as extended JSON object

BODY:

```
{ "method": "phonebook.userid_read",
  "params": { "access_token": "0005gOjCOlMH8F2x", "username": "myuser" } }
```

RESPONSE:

```
{"result": [user ID] }
```

Sample response: {"result": "24"}

Response (when username parameter is missing): {"result": "Missing >>username<< parameter"}

Response (when user doesn't exist): {"result": "Wrong >>username<< parameter"}

RESPONSE (EXTENDED):

Response:

```
{"result":{"uid": [user ID],"status":"ok"}}
```

Sample response: {"result": {"uid": "24", "status": "ok"}}

Response (when wrong logindata):

```
{"result": {"error_text": "Invalid login or password", "status": "error"}}
```

Response (when wrong access token):

```
{"result": {"error_text": "Invalid access token", "status": "error"}}
```

Response (when username parameter is missing):

```
{"result": {"error_text": "Missing >>username<< parameter", "status": "error"}}
```

Response (when user doesn't exist):

```
{"result": {"error_text": "Wrong >>username<< parameter", "status": "error"}}
```

63. Group members read: HTTP GET method

HTTP GET METHOD:

https://url-of-smseagle/http_api/group_members_read

Parameter	Description
access_token	authentication access token (see details in point API Authentication)
login	your user to login to SMSEagle (see details in point API Authentication)
pass	your password to login to SMSEagle
group_id	ID of group to be queried
user_id	<i>(optional parameter) show only contacts created by user with given ID</i>
public	<i>(optional parameter) 0 = private, 1 = public</i>
responsetype	<i>(optional parameter) text = format response as text (default), xml = format response as XML object</i>

EXAMPLES:

https://url-of-smseagle/http_api/group_members_read?access_token=0005gOjCOlMH8F2x&group_id=11

RESPONSE:

Sample response: [link](#)

Response (when wrong or missing group_id parameter): **Wrong or missing >>group_id<< parameter**

Response (when wrong user_id parameter): **Wrong >>user_id<< parameter**

Response (when wrong public parameter): **Wrong >>public<< parameter**

Response (when result set is empty): **No data to display**

RESPONSE (XML):

Response:

```
<xml>
  <contacts>
    <contact>
      <ID>17</ID>
      <Name>mycontact1</Name>
      <Number>23456</Number>
      <id_user>1</id_user>
      <is_public>true</is_public>
    </contact>
    <contact>
      <ID>24</ID>
      <Name>mycontact3</Name>
      <Number>12345</Number>
      <id_user>3</id_user>
      <is_public>false</is_public>
    </contact>
  </contacts>
</xml>
```

Response (when wrong or missing group_id parameter):

```
<xml>
  <error_text>Wrong or missing >>group_id<< parameter</error_text>
  <status>error</status>
</xml>
```

Response (when wrong user_id parameter):

```
<xml>
  <error_text>Wrong >>user_id<< parameter</error_text>
  <status>error</status>
</xml>
```

Response (when wrong public parameter):

```
<xml>
  <error_text> Wrong >>public<< parameter </error_text>
  <status>error</status>
</xml>
```

64. Group members read: JSONRPC method

HTTP POST METHOD:

https://url-of-smseagle/jsonrpc/sms

Parameter	Description
access_token	authentication access token (see details in point API Authentication)
login	your user to login to SMSEagle (see details in point API Authentication)
pass	your password to login to SMSEagle
group_id	ID of group to be queried
user_id	<i>(optional parameter) show only contacts created by user with given ID</i>
public	<i>(optional parameter) 0 = private, 1 = public</i>
responsetype	<i>(optional parameter) simple = format response as simple object with one result field (default), extended = format response as extended JSON object</i>

BODY:

```
{"method": "phonebook.group_members_read",  
"params": {"access_token": "0005gOjCOlMH8F2x", "group_id": "11"}}
```

RESPONSE:

Sample response:

```
{  
  "result": [  
    {"ID": "1706", "Name": "mycontact1", "Number": "23456",  
     "id_user": "1", "is_public": "true"},  
    {"ID": "1693", "Name": "mycontact3", "Number": "12345",  
     "id_user": "3", "is_public": "false"}  
  ]  
}
```

Response (when wrong or missing group_id parameter): {"result": "Wrong or missing >>group_id<< parameter"}

Response (when wrong user_id parameter): {"result": "Wrong >>user_id<< parameter"}

Response (when wrong public parameter): {"result": "Wrong >>public<< parameter"}

RESPONSE (EXTENDED):

Sample response:

```
{  
  "result": {  
    "contacts": [  
      {"ID": "1706", "Name": "mycontact1", "Number": "23456",  
       "id_user": "1", "is_public": "true"},  
      {"ID": "1693", "Name": "mycontact3", "Number": "12345",  
       "id_user": "3", "is_public": "false"}  
    ],  
    "status": "ok"  
  }  
}
```

Response (when wrong logindata):

```
{"result": {"error_text": "Invalid login or password", "status": "error"}}
```

Response (when wrong access token):

```
{"result": {"error_text": "Invalid access token", "status": "error"}}
```

Response (when wrong or missing group_id parameter):

```
{"result": {"error_text": "Wrong or missing >>group_id<<  
parameter", "status": "error"}}
```

Response (when wrong user_id parameter):

```
{"result": "Wrong >>user_id<< parameter"}
```

Response (when wrong public parameter):

```
{"result": "Wrong >>public<< parameter"}
```

65. Call forward read: HTTP GET method

Important Notice: This feature is available only devices with 3G modems.

HTTP GET METHOD:

https://url-of-smseagle/http_api/call_forward_read

Parameter	Description
access_token	authentication access token (see details in point API Authentication)
login	your user to login to SMSEagle (see details in point API Authentication)
pass	your password to login to SMSEagle
modem_no	modem number (<i>default = 1</i>)
responsetype	(<i>optional parameter</i>) text = format response as text (default), xml = format response as XML object

EXAMPLES:

```
https://url-of-smseagle/http_api/call_forward_read?  
access_token=0005gOjCO1MH8F2x&modem_no=1
```

RESPONSE:

Sample response: 0 (*call forwarding disabled*)

Sample response: 1;+48123456789 (*call forwarding enabled to number +48123456789*)

Response (when modem returns wrong response): error

Response (when wrong modem_no parameter): **Wrong parameters**

RESPONSE (XML):

Response:

```
xml>
```

```
<call_forward_status>1;+48123456789 </call_forward_status>
```

```
<status>ok</status>
```

```
</xml>
```

Response (when wrong modem_no parameter):

```
<xml>
```

```
<error_text>Wrong parameters </error_text>
<status>error</status>
</xml>
```

66. Call forward read: JSONRPC method

Important Notice: This feature is available only devices with 3G modems.

HTTP POST METHOD:

<https://url-of-smseagle/jsonrpc/sms>

Parameter	Description
access_token	authentication access token (see details in point API Authentication)
login	your user to login to SMSEagle (see details in point API Authentication)
pass	your password to login to SMSEagle
modem_no	modem number (<i>default = 1</i>)
responsetype	(<i>optional parameter</i>) simple = format response as simple object with one result field (default), extended = format response as extended JSON object

BODY:

```
{"method": "phone.call_forward_read",
"params": {"access_token": "0005gOjCO1MH8F2x", "modem_no": "1"}}
```

RESPONSE:

Sample response:

```
{"result": "0"} (call forwarding disabled)
{"result": "1;+48123456789"} (call forwarding enabled to number +48123456789)
```

Response (when modem/cellular network returns wrong response): {"result": "error"}

Response (when wrong modem_no parameter): {"result": "Wrong parameters"}

RESPONSE (EXTENDED):

Sample response:

```
{"result": {"call_forward_status": "0", "status": "ok"}}
{"result": {"call_forward_status": "1;+48123456789", "status": "ok"}}
```

Response (when wrong parameters):

```
{"result": {"error_text": "Wrong parameters", "status": "error"}}
```

67. Call forward set: HTTP GET method

Important Notice: This feature is available only devices with 3G modems.

HTTP GET METHOD:

https://url-of-smseagle/http_api/call_forward_set

Parameter	Description
access_token	authentication access token (see details in point API Authentication)
login	your user to login to SMSEagle (see details in point API Authentication)
pass	your password to login to SMSEagle
modem_no	modem number (<i>default = 1</i>)
status	status of call forwarding 0 = disabled, 1 = enabled
number	phone number to forward all incoming calls (<i>required when status = 1</i>)
responsetype	(<i>optional parameter</i>) text = format response as text (default), xml = format response as XML object

EXAMPLES:

https://url-of-smseagle/http_api/call_forward_set?
access_token=0005gOjCOlMH8F2x&modem_no=1&modem_no=2&status=1&number=1234567

RESPONSE:

Sample response: OK

Response (when modem returns wrong response): error

Response (when wrong modem_no parameter): **Wrong parameters**

RESPONSE (XML):

Response:

```
<xml>
<status>ok</status>
</xml>
```

Response (when wrong modem_no parameter):

```
<xml>
<error_text>Wrong parameters </error_text>
<status>error</status>
</xml>
```

68. Call forward set: JSONRPC method

Important Notice: This feature is available only devices with 3G modems.

HTTP POST METHOD:

https://url-of-smseagle/jsonrpc/sms

Parameter	Description
access_token	authentication access token (see details in point API Authentication)
login	your user to login to SMSEagle (see details in point API Authentication)
pass	your password to login to SMSEagle

modem_no	modem number (<i>default = 1</i>)
status	status of call forwarding 0 = disabled, 1 = enabled
number	phone number to forward all incoming calls (<i>required when status = 1</i>)
responsetype	(<i>optional parameter</i>) simple = format response as simple object with one result field (default), extended = format response as extended JSON object

BODY:

```
{ "method": "phone.call_forward_set",
  "params": { "access_token": "0005gOjCO1MH8F2x", "modem_no": "1", "status": "1",
             "number": "123456789" } }
```

RESPONSE:

Sample response: { "result": "OK" }

Response (when modem/cellular network returns wrong response): { "result": "error" }

Response (when wrong modem_no parameter): { "result": "Wrong parameters" }

RESPONSE (EXTENDED):

Sample response:

```
{ "result": { "status": "ok" } }
```

Response (when wrong parameters):

```
{ "result": { "error_text": "Wrong parameters", "status": "error" } }
```

PLUGINS AND INTEGRATION MANUALS FOR NMS & AUTH SYSTEMS

SMSEagle has a number of ready-to-use plugins and integration manuals for an easy and quick integration of SMSEagle device with external software (Network Monitoring Systems, Authentication Systems and other). The list grows constantly and is published on SMSEagle website. For a complete and up to date list of plugins please go to: <https://www.smseagle.eu/integration-plugins/>

EXTRAS

Delivery Reports

SMSEagle software allows you to enable delivery reports for each sent SMS. Delivery reports is a feature that allows to receive a confirmation that SMS was received on recipients phone.

In order to enable delivery reports, please go to web-GUI > menu Settings and set "Delivery Reports" to "Yes"

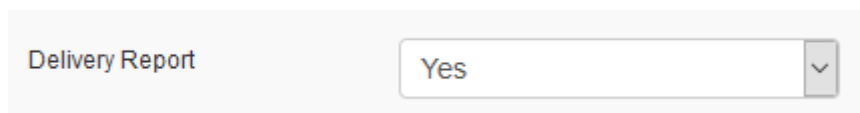

Delivery Report

Once delivery reports are enabled in in web-GUI, you may verify whether SMS was delivered to recipient:

- **In web-GUI**

In menu Folders > Sent items > open the message you want to check. Press "Show Details" in top-right corner of the message. Field "Modem Status" contains information on delivery status

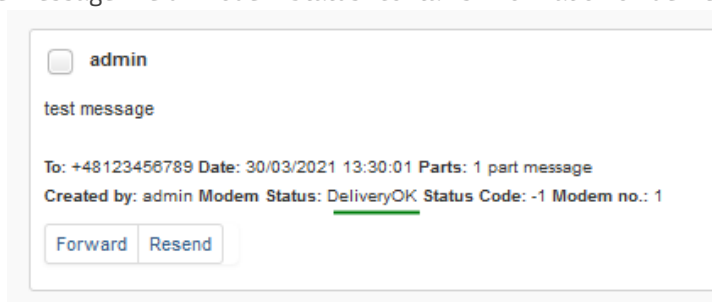

admin
test message
To: +48123456789 Date: 30/03/2021 13:30:01 Parts: 1 part message
Created by: admin Modem Status: DeliveryOK Status Code: -1 Modem no.: 1
Forward Resend

- **Using API**

Use method "read_sms" to fetch data for a selected SMS in sentitems folder. The data will contain columns "Status" and "DeliveryDateTime" contain information about delivery status of the message. For more information about possible values for "Status" column, please refer to chapter 11. [Read SMS: HTTP GET method](#) table "Field Description Of Response Data – Sentitems Folder."

Connecting directly to SMSEagle SQL database

SMSEagle's database operates on PostgreSQL database engine. You may use a direct access to database for reading/writing SMS messages directly from/to database via SQL queries.

The database access for external applications is disabled by default. In order to enable it, go to webGUI > menu Settings and enable to following setting:

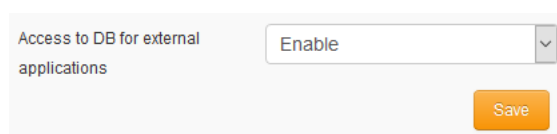

Access to DB for external applications
Save

Once database access is enabled, it is possible to connect to the database from external application using the following credentials:

POSTGRESQL DATABASE CREDENTIALS

Host: IP address of your device

Database name: smseagle

User: smseagleuser

Password: postgreeagle

[Injecting short SMS using SQL](#)

The simplest example is short text message (limited to 160 chars):

```
INSERT INTO outbox (
  DestinationNumber,
  TextDecoded,
  CreatorID,
  Coding,
  Class,
  SenderID
) VALUES (
  '1234567',
  'This is a SQL test message',
  'Program',
  'Default_No_Compression',
  -1,
  'smseagle1'
);

INSERT INTO user_outbox (
  id_outbox,
  id_user
) SELECT CURRVAL(pg_get_serial_sequence('outbox','ID')), 1;
```

In the above example the message will belong to user with **id_user** 1 (default 'admin'). You can find id_user values for other users in table public."user".

Inserting multipart messages is a bit trickier, you need to construct also UDH header and store it hexadecimally written into UDH field. Unless you have a good reason to do this manually, use API.

For long text message, the UDH starts with 050003 followed by byte as a message reference (you can put any hex value there, but it should be different for each message, D3 in following example), byte for number of messages (02 in example, it should be unique for each message you send to same phone number) and byte for number of current message (01 for first message, 02 for second, etc.).

For example, long text message of two parts could look like following:

```
INSERT INTO outbox (
    "DestinationNumber",
    "CreatorID",
    "MultiPart",
    "UDH",
    "TextDecoded",
    "Coding",
    "Class",
    "SenderID"
) VALUES (
    '1234567',
    'Program',
    'true',
    '050003D30201',
    'Lorem ipsum dolor sit amet, consectetur adipiscing elit, sed do
    eiusmod tempor incididunt ut labore et dolore magna aliqua. Ut enim ad
    minim veniam, qui',
    'Default_No_Compression',
    -1,
    'smseagle1'
)

INSERT INTO outbox_multipart (
    "ID",
    "SequencePosition",
    "UDH",
    "TextDecoded",
    "Coding",
    "Class"
) SELECT
    CURRVAL(pg_get_serial_sequence('outbox','ID')),
    2,
    '050003D30202',
    's nostrud exercitation ullamco laboris nisi ut aliquip ex ea commodo
    consequat.',
    'Default_No_Compression',
    -1;

INSERT INTO user_outbox (
    id_outbox,
    id_user
) SELECT
```

```
CURRVAL(pg_get_serial_sequence('outbox','ID')),  
1;
```

Note: Adding UDH means that you have less space for text, in above example you can use only 153 characters in single message.

We have added some useful scripts which may be used to delete SMS messages from database through Linux CLI.

Scripts are located at following directory:

`/mnt/nand-user/scripts/`

- **db_delete** – script for deleting SMS from folders Inbox, SentItems older than provided date.
Usage:
`./db_delete YYYYMMDDhhmm`
- **db_delete_7days** – script for deleting SMS from folders Inbox, SentItems older than 7 days.
Usage:
`./db_delete_7days`
- **db_delete_allfolders** – script for cleaning PostgreSQL database folders (Inbox, SentItems, Outbox). Specially designed to run periodically through *cron*. Usage:
`./db_delete_allfolders`
- **db_delete_select** – script for deleting SMS from chosen database folder (Inbox, Outbox, SentItems, Trash). Usage:
`./db_delete_select {inbox|outbox|sentitems|trash}`

Adding script to system *cron* daemon

1) Create a file inside `/etc/cron.d/` directory with your desired name (eg. *pico db_cleaner*)

2) Example content of this file:

```
0 0 1 * * root /mnt/nand-user/scripts/db_delete_allfolders
```

This will run cleaning script every 1st day of month.

“Simple Network Management Protocol (SNMP) is an Internet-standard protocol for managing devices on IP networks. It is used mostly in network management systems to monitor network-attached devices for conditions that warrant administrative attention” (source: Wikipedia).

SMSEagle device has a built-in Net-SNMP agent. The SNMP agent provides access to Linux Host MIB tree of the device, and additionally (using extension NET-SNMP-EXTEND-MIB) allows access to custom metrics specific to SMSEagle.

Available SNMP metrics that describe a state of a SMSEagle device are:

Metric name	Description	OID
GSM_Signal	Returns 3G/4G signal strength in percent. Value range: 0-100. If modem is disconnected from 3G/4G network GSM_Signal returns 0.	.1.3.6.1.4.1.8072.1.3.2.3.1.2.11.71.83.77.95.83.105.103.110.97.108.49
GSM_NetName1	Returns Network Name used on current SIM card	.1.3.6.1.4.1.8072.1.3.2.3.1.2.12.71.83.77.95.78.101.116.78.97.109.101.49
FolderOutbox_Total	Returns number of SMS messages in Outbox folder (outgoing queue length)	.1.3.6.1.4.1.8072.1.3.2.3.1.2.18.70.111.108.100.101.114.79.117.116.98.111.120.95.84.111.116.97.108
FolderInbox_Total	Returns number of SMS messages in Inbox folder	.1.3.6.1.4.1.8072.1.3.2.3.1.2.17.70.111.108.100.101.114.73.110.98.111.120.95.84.111.116.97.108
FolderSent_Last24H	Returns number of SMS messages sent from the device within last 24 hours	.1.3.6.1.4.1.8072.1.3.2.3.1.2.18.70.111.108.100.101.114.83.101.110.116.95.76.97.115.116.50.52.72
FolderSent_Last1M	Returns number of SMS messages sent from the device within last month	.1.3.6.1.4.1.8072.1.3.2.3.1.2.17.70.111.108.100.101.114.83.101.110.116.95.76.97.115.116.49.77
FolderSent_Last24HSendErr	Returns number of SMS messages sent with error within last 24h. Error occurs when 3G/4G modem cannot send SMS message or message is rejected by 3G/4G carrier	.1.3.6.1.4.1.8072.1.3.2.3.1.2.25.70.111.108.100.101.114.83.101.110.116.95.76.97.115.116.50.52.72.83.101.110.100.69.114.114

Temp	Returns last value of Temperature (in °C) from internal DHT22 sensor. Requires sensor to be enabled.	.1.3.6.1.4.1.8072.1.3.2.4.1.2.4.84.101.109.112.1
Humidity	Returns last value of Humidity (in %) from internal DHT22 sensor. Requires sensor to be enabled.	.1.3.6.1.4.1.8072.1.3.2.3.1.2.8.72.117.109.105.100.105.116.121

RESULT VALUES

- Using OID

Result values for each custom metric are available and can be fetched from OID given in table above.

- Using textual name

Alternatively result values for each custom metric can be fetched using textual names from OID tree under: NET-SNMP-EXTEND-MIB::nsExtendOutputFull."[METRIC NAME]"

For example:

*Result value for parameter **GSM_Signal**:*

NET-SNMP-EXTEND-MIB::nsExtendOutputFull.'GSM_Signal'

If your chosen SNMP tool cannot access NET-SNMP-EXTEND-MIB objects, you can download MIB definitions from: <https://www.smseagle.eu/download/NET-SNMP-EXTEND-MIB.txt>

READING RESULT VALUES

In order to test-read the parameter values from SNMP agent you can use any tools available for SNMP protocol (for example: NET-SNMP library for Linux or iReasoning MiB-Browser for Windows).

EXAMPLE OF READING **GSM_SIGNAL** VALUE USING NET-SNMP LIBRARY

a) Command for reading the result value:

```
snmpget -v 2c -c public localhost
.1.3.6.1.4.1.8072.1.3.2.3.1.2.11.71.83.77.95.83.105.103.110.97.108.49
```

Result:

```
NET-SNMP-EXTEND-MIB::nsExtendOutputFull."GSM_Signal" = STRING: 54
```

Comment: GSM/3G/4G Signal strength value is 54%

EXAMPLE OF READING **GSM_NETNAME1** VALUE USING NET-SNMP LIBRARY

a) Command for reading the result value:

```
snmpget -v 2c -c public localhost
.1.3.6.1.4.1.8072.1.3.2.3.1.2.12.71.83.77.95.78.101.116.78.97.109.101.49
```

Result:

```
NET-SNMP-EXTEND-MIB::nsExtendOutputFull."GSM_NetName1" = STRING: PLAY
```

Comment: Currently used network on SIM card is PLAY

EXAMPLE OF READING **FOLDEROUTBOX_TOTAL** VALUE USING NET-SNMP LIBRARY (AND TEXTUAL NAME OF METRIC)

a) Command for reading the result value:

```
snmpget -v 2c -c public ip-of-smseagle 'NET-SNMP-EXTEND-
MIB::nsExtendOutputFull."FolderOutbox_Total"'
```

Result:

```
NET-SNMP-EXTEND-MIB::nsExtendOutputFull."FolderOutbox_Total" = STRING: 0
```

Comment: Number of SMS messages waiting in outbox queue is 0

EXAMPLE OF READING **SYSTEMUPTIME** FROM LINUX HOST USING NET-SNMP LIBRARY

a) Command for reading the result value:

```
snmpget -v 2c -c public ip-of-smseagle system.sysUpTime.0
```

Result:

```
DISMAN-EVENT-MIB::sysUpTimeInstance = Timeticks: (216622) 0:36:06.22
```

Comment: Linux system is up for 36 hours, 6.22 minutes

EXAMPLE OF BROWSING SMSEAGLE EXTENSION PARAMETERS IN MIB TREE USING NET-SNMP LIBRARY

a) Command for reading the result value:

```
snmpwalk -v 2c -c public ip-of-smseagle .1.3.6.1.4.1.8072.1.3.2.3.1.2
```

Result:

```
NET-SNMP-EXTEND-MIB::nsExtendOutputFull."GSM_Signal" = STRING: 54
NET-SNMP-EXTEND-MIB::nsExtendOutputFull."GSM_NetName1" = STRING: PLAY
NET-SNMP-EXTEND-MIB::nsExtendOutputFull."FolderInbox_Total" = STRING: 15
NET-SNMP-EXTEND-MIB::nsExtendOutputFull."FolderSent_Last1M" = STRING: 19
NET-SNMP-EXTEND-MIB::nsExtendOutputFull."FolderOutbox_Total" = STRING: 0
NET-SNMP-EXTEND-MIB::nsExtendOutputFull."FolderSent_Last24H" = STRING: 0
NET-SNMP-EXTEND-MIB::nsExtendOutputFull."FolderSent_Last24HSendErr" = STRING: 0
```

EXAMPLE OF BROWSING SMSEAGLE EXTENSION PARAMETERS IN MIB TREE USING MIB-BROWSER

The screenshot shows the iReasoning MIB Browser interface. The top menu bar includes File, Edit, Operations, Tools, Bookmarks, and Help. The address bar shows 'Address: 192.168.1.106' and 'OID: .1.3.6.1.4.1.8072.1.3.2.3.1.2'. The left pane displays the MIB Tree structure, with the following path highlighted: iso.org.dod.internet > mgmt > private > enterprises > netSnmp > netSnmpObjects > nsExtensions > nsSnmpExtendMIB > nsExtendObjects > nsExtendNumEntries > nsExtendConfigTable > nsExtendOutput1Table > nsExtendOutput1Entry > nsExtendOutput1Line > nsExtendOutputFull. The right pane shows a 'Result Table' with the following data:

Name/OID	
nsExtendArgs.10.71.83.77.95.83.105.103.110.97.108	signal
nsExtendArgs.17.70.111.108.100.101.114.73.110.98.111.120.95.84.111.116.97.108	inbox
nsExtendArgs.17.70.111.108.100.101.114.83.101.110.116.95.76.97.115.116.49.77	sentIm
nsExtendArgs.18.70.111.108.100.101.114.79.117.116.98.111.120.95.84.111.116.97.108	outbox
nsExtendArgs.18.70.111.108.100.101.114.83.101.110.116.95.76.97.115.116.50.52.72	sent24h
nsExtendOutputFull.10.71.83.77.95.83.105.103.110.97.108	54
nsExtendOutputFull.17.70.111.108.100.101.114.73.110.98.111.120.95.84.111.116.97.108	74
nsExtendOutputFull.17.70.111.108.100.101.114.83.101.110.116.95.76.97.115.116.49.77	504
nsExtendOutputFull.18.70.111.108.100.101.114.79.117.116.98.111.120.95.84.111.116.97.108	0
nsExtendOutputFull.18.70.111.108.100.101.114.83.101.110.116.95.76.97.115.116.50.52.72	0

Below the MIB Tree, a table shows details for the selected object:

Name	Value
Name	nsExtendOutputFull
OID	.1.3.6.1.4.1.8072.1.3.2.3.1.2
MIB	NET-SNMP-EXTEND-MIB
Syntax	DISPLAYSTRING
Access	read-only
Status	current
DefVal	
Augments	nsExtendConfigEntry

Setting up SNMP v3 access control

By default, SMSEagle devices uses SNMP v2 access control. Using v3 can strengthen security, however is not mandatory. To easily switch to SNMP v3 access control we've prepared special shell script located at `/mnt/nand-user/smseagle` directory.

1. Log in via SSH using root account
2. Navigate to:
`cd /mnt/nand-user/smseagle/`
3. Configuration script:
`./snmpv3`
4. Script can run with following parameters:
 - i. `add`
 - ii. `del`
 - iii. `enablev2`
 - iv. `disablev2`
5. To add v3 USER please run:
`./snmpv3 add USERNAME PASSWORD ENCRYPTIONPASSWORD`
6. To delete USER please run:
`./snmpv3 del`

7. To disable v2 access policy run:

```
./snmpv3 disablev2
```

8. To enable v2 access policy run:

```
./snmpv3 enablev2
```

Forwarding logs to external server

Our devices run rsyslog for log managing. Here we describe how to configure additional rules for rsyslog daemon: rsyslogd. This is only a brief excerpt from rsyslog manual website. Full information is available at: <https://www.rsyslog.com/>

Rsyslogd configuration is managed using a configuration file located at */etc/rsyslog.conf*

- At the bottom of the configuration file add:

```
*.* action(type="omfwd" target="SERVER_IP" port="PORT" protocol="PROTOCOL"
action.resumeRetryCount="10"
queue.type="linkedList" queue.size="10000")
```

where: SERVER_IP – IP (or FQDN) address of receiving server
PORT – port on receiving server
PROTOCOL one of the values: tcp, udp

- Example:

```
*.* action(type="omfwd" target="192.168.0.250" port="10514" protocol="tcp"
action.resumeRetryCount="10"
queue.type="linkedList" queue.size="10000")
```

- SSL-encryption of your log traffic: please have a look at this article: https://www.rsyslog.com/doc/v8-stable/tutorials/tls_cert_summary.html

Automatic software updates check

SMSEagle software is under process of continual improvement. We listen to our customers, and new releases are based on our customer's inputs/requests. Software updates are released frequently, and offer access to new features and fixes to reported issues. Web-GUI offers you a possibility to automatically check for new software updates. This can be done in two ways:

MANUAL CHECK

In order to manually check for available software updates, go to menu Settings > tab Maintenance. Click on the button "Check manually now". At the top pops up a balloon in red with information if it is up-to-date.

AUTOMATIC CHECK

In order to start automatic checks for software updates go to menu Settings > tab Maintenance, and check the option "Automatically check for software updates". This will enable periodic checks (once a month) for available software updates. If a new update is available, a message "Update Available" will appear in menu Settings> Sysinfo – next to the current software version number.

If you select "Notify Admin about new software version by SMS", the device will additionally send SMS to the default admin account (if the phone number is entered in the account) with a notification about new software update.

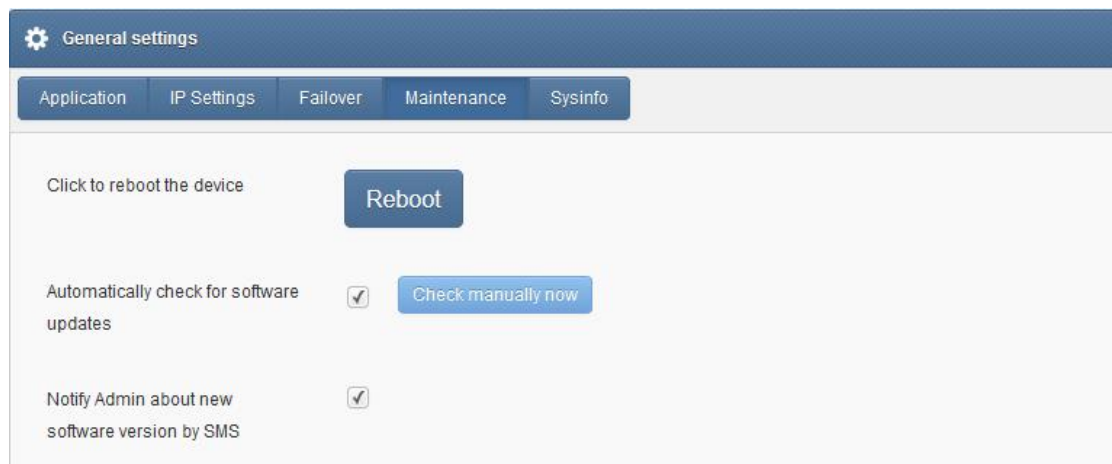

Screenshot from "General settings-Maintenance"

Notice: Your SMSEagle device must have a HTTPS connectivity with address www.smseagle.eu in order for this feature to work.

Knowledgebase & Support Portal

More information and useful hints about SMSEagle device configuration can be found in our online knowledgebase and support portal at: <https://support.smseagle.eu>

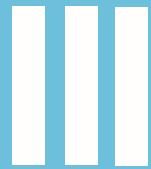

TROUBLESHOOTING

TROUBLESHOOTING

To make sure that the device is working properly, follow the three steps:

1. Verification of LEDs
2. Checking the device configuration (IP Settings)
3. Check the device logs (description below)

Verification of LEDs

Normal operation of the device is signaled by LEDs as follows:

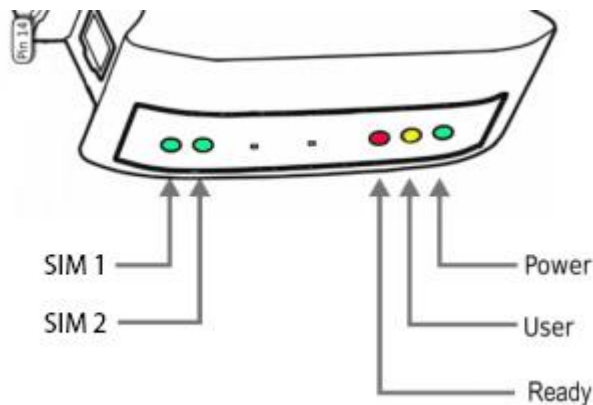

LED	Correct operation
Power (PWR)	Continuously lit
User	Blinks during flashdisk read/write
Ready (RDY)	Blinking
SIM1 (only 3G device)	Slow flashing in stand-by mode, Quick flashing when modem 1 in use
SIM2 (only 3G device)	Not used

Checking the device information

The device information (device type, software version, modem IMEI, IMSI, network signal strength, network name) can be found under menu "Settings" > "Sysinfo".

Device logs

Under menu "Settings" > "Sysinfo" you can find latest lines of device logs: modem log, database log and system log. In case of any problems with the device these logs are a valuable source of troubleshooting information.

Extended device logs can be downloaded via button "Download device logs" in menu "Settings" > "Sysinfo".



When the device is not reachable



1. Check if the device is correctly connected to the network. Check LED status of RJ45 socket.
2. In the case when the device does not respond due to a malfunction or incorrect user settings please reboot the device by disconnecting and connecting power source (or pressing Reset switch).
3. If you still cannot connect with the device, it is possible to restore to factory IP settings by using the SW button.

Restoring factory defaults

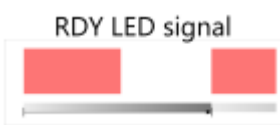
This action restores the following settings to default values: **IP settings, time zone settings, database content, Linux OS users/passwords**

In order to restore factory defaults, proceed with the following steps:

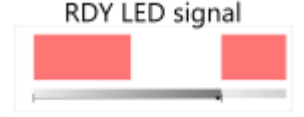
LED signaling	USER actions	System reaction
	1. When the device is ready to operate	
	2. Press and hold SW button for 10 seconds	Restore service is counting down.
	3. Release SW button after 10 seconds. User LED will begin to blink.	System is reading factory defaults. Factory settings are being applied to the device.

 <p>RDY LED signal</p>  <p>USER LED signal</p>	<p>4. Wait until system reboots.</p> <p>Default settings are restored.</p>	<p>System is going for a reboot.</p>
--	---	--------------------------------------

Please note, that after reboot the device will be finishing the process of factory reset, therefore it can take longer for the system to start.

IV

SERVICE & REPAIR

SERVICE & REPAIR

Warranty

Your SMSEagle comes with a standard 1 year of technical support and hardware repair warranty coverage. The standard warranty can be extended during device purchase to 3-years coverage (check your purchase conditions). For a detailed information on warranty terms and conditions check warranty card that comes with your device or follow the link: www.smseagle.eu/docs/general_warranty_terms_and_conditions.pdf

Service

Before contacting with support team, be sure that you have read Troubleshooting section of this manual. SMSEagle Support Team is available by email or telephone.

Support Portal: <https://support.smseagle.eu>

Email: support@smseagle.eu

Phone: + 48 61 6713 413

The support service is provided by:
PROXIMUS Radoslaw Janowski
ul. Piątkowska 163,
60-650 Poznan, Poland

WHEN CONTACTING SUPPORT TEAM, BE PREPARED TO PROVIDE THE FOLLOWING INFORMATION:

System Logs

Go to menu Settings > Sysinfo > "Download device logs". Provide log package to support team when requested.

MAC address

Each SMSEagle device has its unique MAC address. MAC address is printed on the device body or can be found in menu Settings > IP Settings

V

**TECH SPECS
& SAFETY
INFORMATION**

Technical Specification

HARDWARE SPECIFICATION

- Processor type:
 - hardware Rev. 3, Rev. 2: Broadcom BCM2837 1.2 GHz quad-core ARM Cortex-A53 (64-bit)
 - hardware Rev.1: Broadcom BCM2835 0.7GHz ARM11
- Operational memory (RAM):
 - hardware Rev. 3, Rev.2: 1GB LPDDR2 @ 900 MHz
 - hardware Rev.1: 512 MB SDRAM @ 400 MHz
- 4GB eMMC storage
- Network interface: Ethernet (1xRJ45)
 - hardware Rev.3: Gigabit Ethernet 10/100/1000 TX
 - hardware Rev.2, Rev.1: Fast Ethernet 10/100 TX
- 1x HDMI port for debugging purposes
- Other external ports
 - hardware Rev.3: 2xUSB 2.0, 4x DI, 4x DO, 1x 1Wire
 - hardware Rev.2, Rev.1: 1xUSB 2.0, 2x DI, 2x DO, 2x RS232 serial ports
- Digital Input/Output port types:
 - hardware Rev.3: DI type "pull-up resistor". DO type "open collector"
 - hardware Rev.2, Rev.1: DI/DO voltage input/output
- RTC Clock: RTC 240B SRAM, Watchdog timer
- Internal humidity & temperature sensor: Accuracy $\pm 0,5$ °C, ± 2 %RH
- Power consumption: max 12W
- Noise level: Fan-less
- Dimensions: (width x depth x height) 35 x 120 x 101 mm
- Weight: 350g
- Casing: ABS, DIN rail installation
- Operating parameters:
 - Operating temperature: 0 ~ 40°C
 - Humidity: 8 ~ 90% RH (no condensation)

- Internal modem

Device type NXS-9700-3G:

- Waveband: GSM, UMTS
- GSM/GPRS quad-band 850/900/1800/1900 MHz
- UMTS 800/850/900/AWS 1700/1900/2100 MHz
- Output power (Rated):
 - E-GSM 900: Class 4, DCS 1800: Class 1
 - EDGE 900: Class E2, EDGE 1800: Class E2
 - FDD I: Class 3, FDD VIII: Class 3

Device type NXS-9700-4G:

- Waveband: UMTS, LTE
 - LTE Bands:
 - LTE FDD: 1-5, 7, 8, 12, 13, 17, 20, 25, 26, 28, 29, 30 (Rx only), 66
 - LTE TDD: 38, 40, 41
 - 3G Bands: 1, 2, 4, 5, 8
 - Output power:
 - Class 3 (0.2 W, 23 dBm) @ LTE
 - Class 3 (0.25 W, 23 dBm) @ 3G
 - Class 4 (2W) @ E-GSM 900
 - Class 1 (1W) @ DCS 1800
- SIM card standard: mini
 - Antenna connector: SMA
 - Country of origin: European Union (Poland)

POWER SUPPLY

AC line input

Voltage ranges: 100–240V alternating current (AC)

Frequency: 50–60Hz single phase

DC plug type: 5.5/2.5

ANTENNA

- Device type NXS-9700-3G:

- Omnidirectional 3dBi antenna with magnetic foot
- Waveband: GSM, UMTS
- Cable length 3m
- Plug type: SMA
- Impedance: 50 Ohm
- Device type NXS-9700-4G:
 - Omnidirectional 2dBi antenna with magnetic foot
 - Waveband: UMTS, LTE
 - Cable length 3m
 - Plug type: SMA
 - Impedance: 50 Ohm

SENDING/RECEIVING THROUGHPUT

- Incoming transmission rate: up to 30 SMS/min
- Outgoing transmission rate: up to 30 SMS/min

SOFTWARE PLATFORM

- Operating system: Linux
 - hardware Rev. 3: kernel 4.14
 - hardware Rev. 2: kernel 4.4
 - hardware Rev. 1: kernel 4.1
- built-in Apache2 web server
- built-in PostgreSQL database server
- built-in Postfix email server
- built-in SNMP agent
- built-in NTP-client
- built-in Failover (HA-cluster) service
- watchdog mechanism for 3G/4G modem
- modern responsive web interface

Important Safety Information

This chapter provides important information about safety procedures. For your safety and that of your equipment, follow these rules for handling your device.

WARNING: Incorrect storage or use of your device may void the manufacturer's warranty. Failure to follow these safety instructions could result in fire, electric shock, or other injury or damage.

Always take the following precautions.

Disconnect the power plug from AC power source or if any of the following conditions exist:

- the power cord or plug becomes frayed or otherwise damaged
- you spill something into the case
- the device is exposed to rain or any other excess moisture
- the device has been dropped or the case has been otherwise damaged

Be sure about that the use of this product is allowed in your country and in the environment required. As with any other telecommunication equipment, the use of this product may be dangerous and has to be avoided in the following areas: where it can interfere with other electronic devices in environments such as hospitals, airports, aircrafts, etc.; where there is risk of explosion such as gasoline stations, oil refineries, etc.

It is responsibility of the user to enforce the country regulation and the specific environment regulation.

Do not disassemble the product; any mark of tampering will compromise the warranty validity.

Every device has to be equipped with a proper antenna with specific characteristics. The antenna has to be installed with care in order to avoid any interference with other electronic devices and has to be installed with the guarantee of a minimum 20 cm distance from the body. In case of this requirement cannot be satisfied, the system integrator has to assess the final product against the SAR regulation.

DISCLAIMER: The manufacturer is not responsible for any damages caused by inappropriate installation, not maintaining the proper technical condition or using a product against its destination.

REGULATORY STATEMENTS

EU declaration of conformity

Hereby, PROXIMUS Radoslaw Janowski, owner of SMSEagle brand, declares that the radio equipment type SMSEagle NXS-9700-3G, NXS-9700-4G is in compliance with Directive 2014/53/EU.

The full text of the EU declaration of conformity is available at the following internet address:
www.smseagle.eu/certification

FCC compliance statement

This device complies with part 15 of the FCC rules. Operation is subject to the following two conditions:

- (1) This device may not cause harmful interference, and
- (2) this device must accept any interference received, including interference that may cause undesired operation.

Note:

This equipment has been tested and found to comply with the limits for a Class B device, pursuant to part 15 of the FCC Rules. These limits are designed to provide reasonable protection against harmful interference in a business/commercial non-residential environment. However, there is no guarantee that interference will not occur in a particular installation. If this equipment does cause harmful interference to radio or television reception, which can be determined by turning the equipment off and on, the user is encouraged to try to correct the interference by one or more of the following measures:

- Reorient or relocate the receiving antenna.
- Increase the separation between the equipment and receiver.
- Connect the equipment to an outlet on a circuit different from that to which the receiver is connected.
- Consult the dealer or an experienced radio/TV technician for help.

Important:

This equipment generates, uses, and can radiate radio frequency energy and, if not installed and used in accordance with the manufacturer's instruction manual, may cause harmful interference with radio communications. Operation of this equipment in a residential area is likely to cause harmful interference, in which case you will be required to correct the interference at your own expense. The FCC regulations provide that changes or modifications not expressly approved by SMSEagle™ could void your authority to operate this equipment. This product has demonstrated EMC compliance under conditions that included the use of compliant peripheral devices (antennas) and shielded cables between system components. It is important that you use compliant peripheral devices and shielded cables between system components to reduce the possibility of causing interference to radios, televisions, and other electronic devices.

Canadian regulatory statement

This device complies with Industry Canada license-exempt RSS standard(s). Operation is subject to the following two conditions:

- (1) this device may not cause interference, and
- (2) this device must accept any interference, including interference that may cause undesired operation of the device.

This Class B digital apparatus meets the requirements of the Canadian Interference-Causing Equipment Regulations.

CAN ICES-3 (B)/NMB-3(B)

Avis de conformité à la réglementation d'Industrie Canada

Le présent appareil est conforme aux CNR d'Industrie Canada applicables aux appareils radio exempts de licence. L'exploitation est autorisée aux deux conditions suivantes:

- (1) l'appareil ne doit pas produire de brouillage,
- (2) l'utilisateur de l'appareil doit accepter tout brouillage radioélectrique subi, même si le brouillage est susceptible d'en compromettre le fonctionnement.

Cet appareil numérique de classe B répond aux exigences du Règlement sur le matériel brouilleur du Canada.

CAN ICES-3 (B)/NMB-3(B)

RF Exposure limits

This device complies with radiation exposure limits set forth for an uncontrolled environment. In order to avoid the possibility of exceeding the radio frequency exposure limits, human proximity to the antenna shall not be less than 20 cm (8 inches) during normal operation.

Disposal and recycling information

Your SMSEagle device contains lithium-ion battery for RTC backup. Dispose of the device and/or battery in accordance with local environmental laws and guidelines.

European Union—Disposal Information



The symbol above means that according to local laws and regulations your product shall be disposed of separately from household waste. When this product reaches its end of life, take it to a collection point designated by local authorities. The separate collection and recycling of your product at the time of disposal will help conserve natural resources and ensure that it is recycled in a manner that protects human health and the environment.

For disposal in countries outside of the European Union

This symbol is only valid in the European Union (EU). If you wish to discard this product please contact your local authorities or dealer and ask for the correct method of disposal.

Restriction of Hazardous Substances Directive (RoHS)

European Union RoHS

SMSEagle devices sold in the European Union, on or after 3 January 2013 meet the requirements of Directive 2015/863 on the restriction of the use of certain hazardous substances in electrical and electronic equipment ("RoHS 3").



Ul. Piątkowska 163, 60-650
Poznań, Poland | Europe

T +48 61 6713 413

E hello@smseagle.eu

www.smseagle.eu